

# Traffa

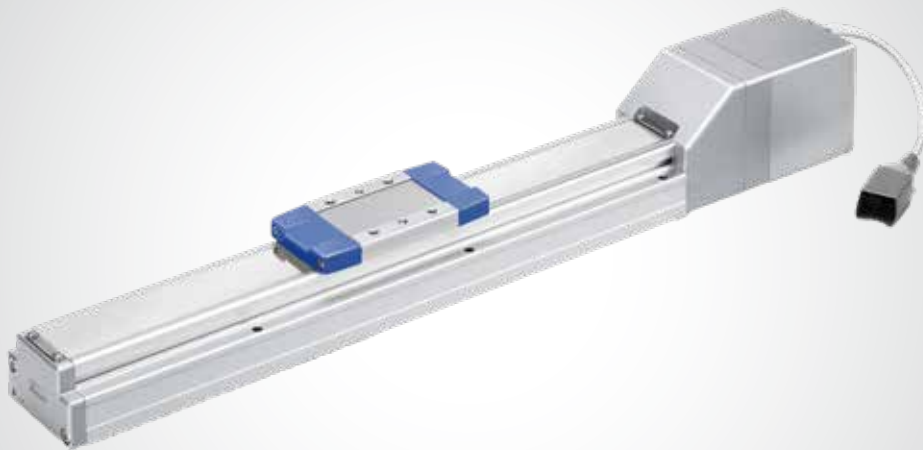

**TRAFFA**  
TECHNISCHES BÜRO

**Elektr. Antrieb mit Spindel LEKFS**



*Innovative Antriebslösungen*

*Der optimale Antrieb individuell für Ihre Anforderung*



# Operation Manual

PRODUCT NAME

## Electric Actuator / Slider type

《Battery-less absolute encoder type (Step motor 24VDC)》

MODEL / Series / Product Number

## LEKFS Series

Applicable models : LEKFS□E

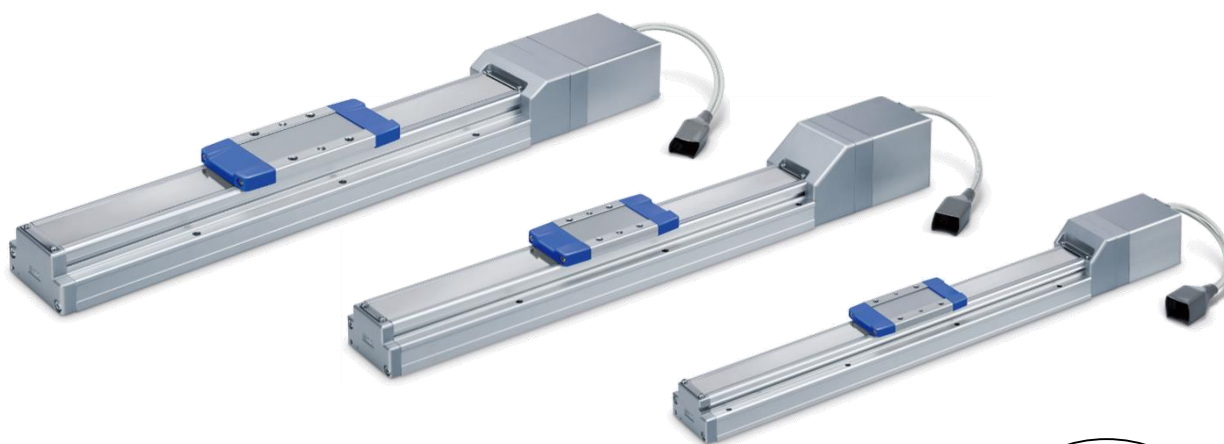

Controller  
**JXC□1 Series**



#This manual describes the actuators operation in combination with the JXC\*1 series controllers.  
#Refer to the manual relevant to the controller being used for full operating instructions.

# SMC Corporation

Safety Instructions .....	2
1. Specification.....	4
1.1 How to Order.....	4
1.2 Specification .....	5
1.3 Construction .....	6
2. Electric Actuators Precautions.....	8
2.1 Wiring/Cables.....	8
2.2 Design/Selection.....	9
2.3 Mounting .....	10
2.4 Handling .....	11
2.5 Operating Environment.....	13
2.6 Maintenance.....	13
2.7 Actuator with Lock .....	14
2.8 Design/Selection.....	15
2.9 Handling .....	15
2.10 Mounting .....	16
2.11 Power Supply .....	17
2.12 Grounding .....	17
2.13 Wiring .....	17
2.14 Maintenance.....	18
3. LEKFS series slider type / Common precautions .....	19
3.1 Design / selection .....	19
3.2 Handling .....	19
3.3 Mounting .....	20
3.4 Precaution on maintenance.....	21
3.5 How to detach and attach the dust seal band.....	22
3.6 Replacement of belt .....	23
4. Troubleshooting .....	24



# LEKFS Series / Electric Actuator Safety Instructions

These safety instructions are intended to prevent hazardous situations and/or equipment damage. These instructions indicate the level of potential hazard with the labels of "Caution," "Warning" or "Danger." They are all important notes for safety and must be followed in addition to International Standards (ISO/IEC)\*1), and other safety regulations.

\*1) ISO 4414: Pneumatic fluid power -- General rules relating to systems.

ISO 4413: Hydraulic fluid power -- General rules relating to systems.

IEC 60204-1: Safety of machinery -- Electrical equipment of machines .(Part 1: General requirements)

ISO 10218: Manipulating industrial robots -Safety.

etc.



## Caution

**Caution** indicates a hazard with a low level of risk which, if not avoided, could result in minor or moderate injury.



## Warning

**Warning** indicates a hazard with a medium level of risk which, if not avoided, could result in death or serious injury.



## Danger

**Danger** indicates a hazard with a high level of risk which, if not avoided, will result in death or serious injury.

## Warning

### 1. The compatibility of the product is the responsibility of the person who designs the equipment or decides its specifications.

Since the product specified here is used under various operating conditions, its compatibility with specific equipment must be decided by the person who designs the equipment or decides its specifications based on necessary analysis and test results.

The expected performance and safety assurance of the equipment will be the responsibility of the person who has determined its compatibility with the product.

This person should also continuously review all specifications of the product referring to its latest catalog information, with a view to giving due consideration to any possibility of equipment failure when configuring the equipment.

### 2. Only personnel with appropriate training should operate machinery and equipment.

The product specified here may become unsafe if handled incorrectly.

The assembly, operation and maintenance of machines or equipment including our products must be performed by an operator who is appropriately trained and experienced.

### 3. Do not service or attempt to remove product and machinery/equipment until safety is confirmed.

1. The inspection and maintenance of machinery/equipment should only be performed after measures to prevent falling or runaway of the driven objects have been confirmed.

2. When the product is to be removed, confirm that the safety measures as mentioned above are implemented and the power from any appropriate source is cut, and read and understand the specific product precautions of all relevant products carefully.

3. Before machinery/equipment is restarted, take measures to prevent unexpected operation and malfunction.

### 4. Contact SMC beforehand and take special consideration of safety measures if the product is to be used in any of the following conditions.

1. Conditions and environments outside of the given specifications, or use outdoors or in a place exposed to direct sunlight.

2. Installation on equipment in conjunction with atomic energy, railways, air navigation, space, shipping, vehicles, military, medical treatment, combustion and recreation, or equipment in contact with food and beverages, emergency stop circuits, clutch and brake circuits in press applications, safety equipment or other applications unsuitable for the standard specifications described in the product catalog.

3. An application which could have negative effects on people, property, or animals requiring special safety analysis.

4. Use in an interlock circuit, which requires the provision of double interlock for possible failure by using a mechanical protective function, and periodical checks to confirm proper operation.



# LEKFS Series / Electric Actuator Safety Instructions

## Caution

**The product is provided for use in manufacturing industries.**

The product herein described is basically provided for peaceful use in manufacturing industries.

If considering using the product in other industries, consult SMC beforehand and exchange specifications or a contract if necessary.

If anything is unclear, contact your nearest sales branch.

## Limited warranty and Disclaimer/Compliance Requirements

The product used is subject to the following "Limited warranty and Disclaimer" and "Compliance Requirements".

Read and accept them before using the product.

### Limited warranty and Disclaimer

1. The warranty period of the product is 1 year in service or 1.5 years after the product is delivered, whichever is first. \*2)

Also, the product may have specified durability, running distance or replacement parts. Please consult your nearest sales branch.

2. For any failure or damage reported within the warranty period which is clearly our responsibility, a replacement product or necessary parts will be provided.

This limited warranty applies only to our product independently, and not to any other damage incurred due to the failure of the product.

3. Prior to using SMC products, please read and understand the warranty terms and disclaimers noted in the specified catalog for the particular products.

\*2) Vacuum pads are excluded from this 1 year warranty.

A vacuum pad is a consumable part, so it is warranted for a year after it is delivered.

Also, even within the warranty period, the wear of a product due to the use of the vacuum pad or failure due to the deterioration of rubber material are not covered by the limited warranty.

### Compliance Requirements

1. The use of SMC products with production equipment for the manufacture of weapons of mass destruction (WMD) or any other weapon is strictly prohibited.

2. The exports of SMC products or technology from one country to another are governed by the relevant security laws and regulation of the countries involved in the transaction. Prior to the shipment of a SMC product to another country, assure that all local rules governing that export are known and followed.

## Caution

**SMC products are not intended for use as instruments for legal metrology.**

Measurement instruments that SMC manufactures or sells have not been qualified by type approval tests relevant to the metrology (measurement) laws of each country.

Therefore, SMC products cannot be used for business or certification ordained by the metrology (measurement) laws of each country.

# 1. Specification

## 1.1 How to Order

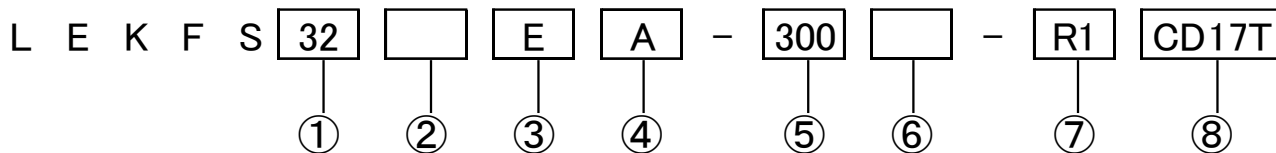

### ① Size

16
25
32
40

### ② Motor mounting positio

Nil	In-line
R	Right side parallel
L	Left side parallel

### ③ Motor type

E	Battery-less Absolute (Step Motor 24VDC)
---	--

### ④ Lead[mm]

Symbol	Size			
	16	25	32	40
H	-	20	24	30
A	10	12	16	20
B	5	6	8	10

### ⑤ Stroke

100	100
to	to
600	600

### ⑥ Motor option

Nil	Without option
B	With lock

### ⑦ Actuator cable type/length

Robotic cable		[m]	
Nil	None	R8	8 *
R1	1.5	RA	10 *
R3	3	RB	15 *
R5	5	RC	20 *

\*For details, refer to the applicable stroke table below.

### Applicable Stroke Table

Size	Stroke					
	100	200	300	400	500	600
16	●	●	●	●	●	-
25	●	●	●	●	●	-
32	●	●	●	●	●	-
40	-	●	●	●	●	●

\*Produced upon receipt of order

### ⑧ Controller

\*Refer to catalog

## ⚠ Caution

**The actuator body and controller are sold as a package.**

If when only the actuator is purchased separately, confirm that the combination of the controller, which you have and the actuator is compatible.

<Be sure to check the following before use.>

- (1) Check that actuator label for model number.  
This matches the controller.

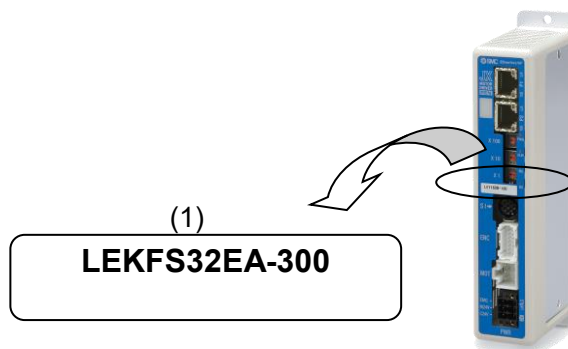

## 1.2 Specification

### Battery-less absolute encoder type (Step motor 24VDC)

Model			LEKFS16		LEKFS25			LEKFS32			LEKFS40				
Actuator specification	Stroke [mm]		100 to 500		100 to 500			100 to 500			200 to 600				
	Work load [kg] *1		Horizontal	14	15	12	25	30	20	45	50	25	55	65	
			Vertical	2	4	0.5	7.5	15	4	10	20	2	2	23	
	Speed [mm/s] *1	In-line	Stroke range	to 400	10 to 700	5 to 360	20 to 1100	12 to 750	6 to 400	24 to 1200	16 to 800	8 to 400	30 to 1200	20 to 850	10 to 300
				401 to 500	10 to 600	5 to 300									
				501 to 600	-	-									
		Parallel	Stroke range	to 400	10 to 700	5 to 360	20 to 900	12 to 600	6 to 300	24 to 800	16 to 650	8 to 325	30 to 750	20 to 550	10 to 300
				401 to 500	10 to 600	5 to 300									
				501 to 600	-	-									
	Max acceleration/deceleration [mm/s <sup>2</sup> ]		3,000												
	Positioning repeatability [mm]		±0.01 (Lead H:±0.02)												
	Lost motion[mm] *2		0.05												
Lead [mm]		10	5	20	12	6	24	16	8	30	20	10			
Impact/Vibration resistance [m/s <sup>2</sup> ] *3		50/20													
Actuation type		Ball screw													
Guide type		Linear guide													
Operating temperature [°C]		5 to 40													
Operating humidity [%RH]		90 or less(No condensation)													
Electric specification	Motor size		□28		□42			□56.4							
	Motor type		Battery-less Absolute (Step Motor 24VDC)												
	Encoder		Battery-less Absolute												
	Power supply voltage [V]		24VDC±10%												
	Power [W] *4		Max. 51		Max. 57			Max. 123			Max. 141				
Lock unit specification	Type *5		Non-magnetizing lock												
	Holding force [N]		20	39	47	78	157	72	108	216	75	113	225		
	Power consumption [W] *6		2.9		5			5			5				
	Power supply voltage [V]		24VDC±10%												

\*1 Speed changes according to the work load. Check "Speed-Work Load Graph" as a Guide on catalog.

Furthermore, if the cable length exceeds 5 m, then it will decrease by up to 10% for each 5 m.

\*2 A reference value for correcting an error in reciprocal operation

\*3 Impact resistance: No malfunction occurred when the actuator was tested with a drop tester in both an axial direction and a perpendicular direction to the lead screw. The test was performed with the actuator in the initial state.

Vibration resistance: No malfunction occurred in a test ranging between 45 to 2000 Hz. The test was performed in both an axial direction and a perpendicular direction to the lead screw. The test was performed with the actuator in the initial state.

\*4 Indicates the max. power during operation (including the controller)

This value can be used for the selection of the power supply.

\*5 With lock only

\*6 For an actuator with lock, add the power consumption for the lock.

### Weight

Series	LEKFS16				
Stroke[mm]	100	200	300	400	500
Product weight[kg]	1.0	1.2	1.4	1.5	1.7
Additional weight with lock[kg]	0.12				

Series	LEKFS25				
Stroke[mm]	100	200	300	400	500
Product weight[kg]	1.8	2.1	2.4	2.6	2.9
Additional weight with lock[kg]	0.3				

Series	LEKFS32				
Stroke[mm]	100	200	300	400	500
Product weight[kg]	3.3	3.7	4.2	4.6	5
Additional weight with lock[kg]	0.5				

Series	LEKFS40				
Stroke[mm]	200	300	400	500	600
Product weight[kg]	5.7	6.3	6.9	7.5	8.1
Additional weight with lock[kg]	0.5				

## 1.3 Construction

### ● In-line type

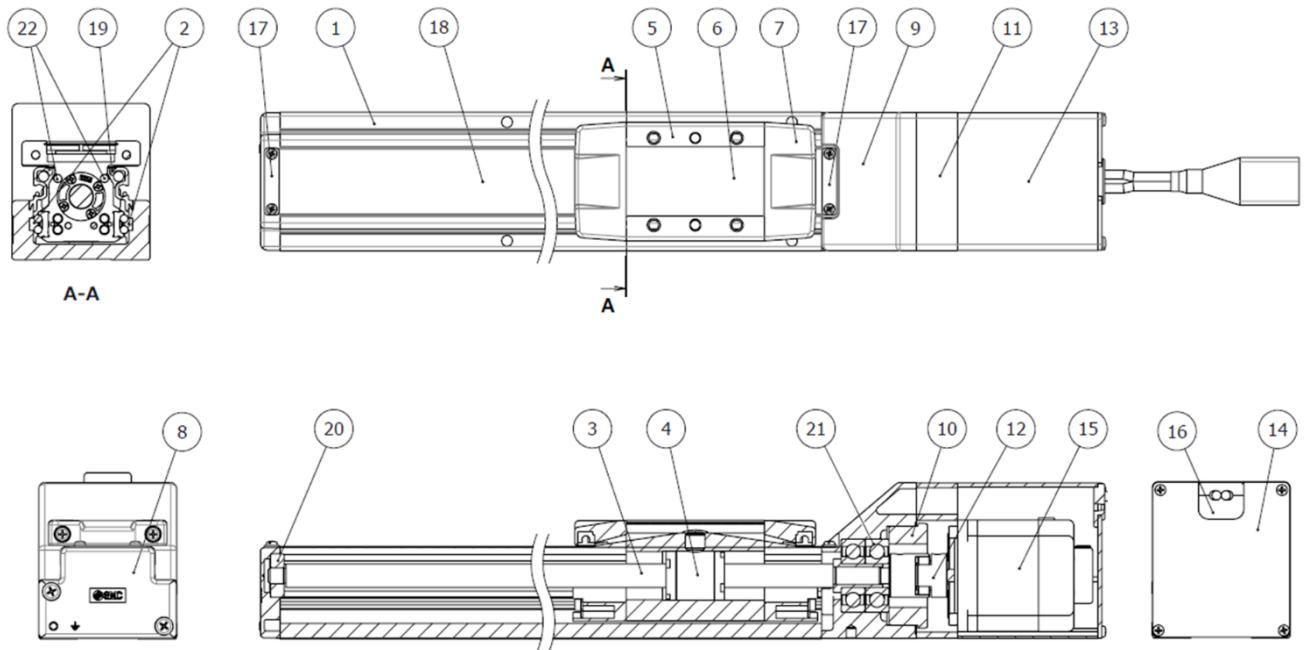

#### Component Parts

No.	Description	Material	Note
1	Body	Aluminum alloy	Anodized
2	Rail guide	-	
3	Ball screw shaft	-	
4	Ball screw nut	-	
5	Table	Aluminum alloy	Anodized
6	Blanking plate	Aluminum alloy	Anodized
7	Seal band holder	Synthetic resin	
8	Housing A	Aluminum die-casted	Coating
9	Housing B	Aluminum die-casted	Coating
10	Bearing stopper	Aluminum alloy	
11	Motor mount	Aluminum alloy	Coating
12	Coupling	-	

No.	Description	Material	Note
13	Motor cover	Aluminum alloy	Anodized
14	End cover	Aluminum alloy	Anodized
15	Motor	-	
16	Rubber bushing	NBR	
17	Band stopper	Stainless steel	
18	Dust seal band	Stainless steel	
19	Seal magnet	-	
20	Bearing	Synthetic resin	
21	Bearing	-	
22	Magnet	-	

#### Replacement Parts/Grease Pack

Order no.
GR-S-010(10g)
GR-S-020(20g)



●R/L side parallel type

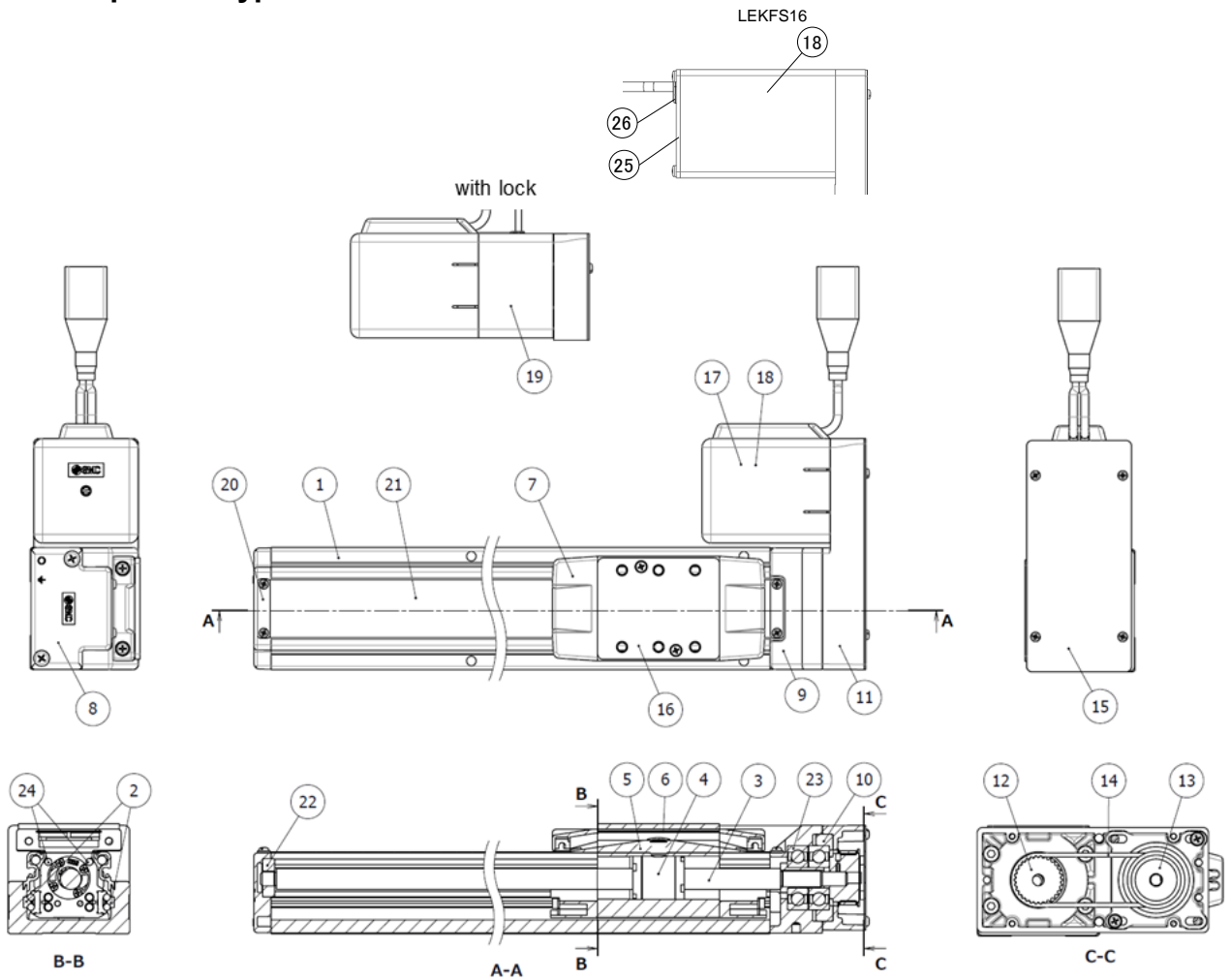

Component Parts

No.	Description	Material	Note
1	Body	Aluminum alloy	Anodized
2	Rail guide	-	
3	Ball screw shaft	-	
4	Ball screw nut	-	
5	Table	Aluminum alloy	Anodized
6	Blanking plate	Aluminum alloy	Anodized
7	Seal band holder	Synthetic resin	
8	Housing A	Aluminum die-casted	Coating
9	Housing B	Aluminum die-casted	Coating
10	Bearing stopper	Aluminum alloy	
11	Return plate	Aluminum die-casted	Coating
12	Pulley	Aluminum alloy	
13	Pulley	Aluminum alloy	

No.	Description	Material	Note
14	Belt	-	
15	Cover plate	Aluminum alloy	Anodized
16	Table spacer	Aluminum alloy	Anodized (LEKFS32 only)
17	Motor	-	
18	Motor cover	Aluminum alloy	Anodized (LEKFS16 only)
		Synthetic resin	
19	Motor cover with lock	Aluminum alloy	Anodized
20	Band stopper	Stainless steel	
21	Dust seal band	Stainless steel	
22	Bearing	Synthetic resin	
23	Bearing	-	
24	Magnet	-	
25	End cover	Aluminum alloy	Anodized (LEKFS16 only)
26	Rubber bushing	NBR	(LEKFS16 only)

## 2. Electric Actuators Precautions

### 2.1 Wiring/Cables

#### ⚠ Warning

1. **Adjustment, installation, inspection, or wiring changes should be conducted after the power supply to this product has been turned off.**  
Electrical shock, malfunction, or damage can result.
2. **Never disassemble the cable. Use only the specified cables.**
3. **Never connect or disconnect the cable or connector with the power on.**

#### ⚠ Caution

1. **Wiring should be done correctly.**  
For each terminal, voltages other than those stipulated in the operation manual should not be applied.
2. **Connect the connector securely.**  
Check for correct connector wiring and polarity.
3. **Handling noise**  
If the noise is at the same wavelength as the signal lines, it will lead to malfunction. As a countermeasure, separate the high and low electrical lines, shorten the length of wiring, etc.
4. **Do not connect power or high-voltage cables in the same wiring path as the unit.**  
The product can malfunction due to noise and surge voltage interference in the signal line from power and high-voltage cables. Separate the wiring of the controller and its peripheral device from that of power and high-voltage cables.
5. **Be careful that cables are not caught by actuator movement.**
6. **Operate with cables such that they are not easily moved.**  
Avoid bending cables at sharp angles where they enter the product.
7. **Avoid twisting, folding, rotating, or applying external force to the cable.**  
Electric shock, wire breakage, contact failure, or a loss of product control may occur.
8. **Do not move cables connected to the actuator.**  
The motor and lock cables are not robotic cables and can be broken when moved. Therefore, secure the cables and the connectors (part "A" in the figure below) in place during set up.

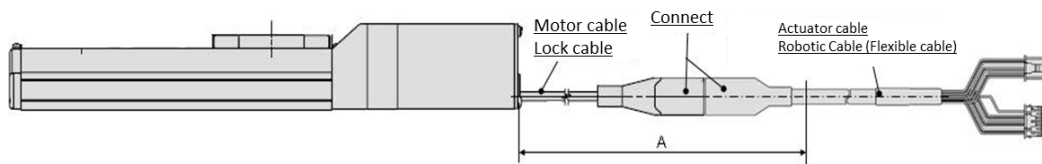

9. **Select a "robotic cable (flexible cable)" when repeated bending of the actuator cable is required. Also, do not put cables into a flexible moving tube with a radius smaller than the specified value (50 mm or longer).**  
Electric shock, wire breakage, contact failure, or a loss of product control may occur if "standard cables" are used for repeated bending.

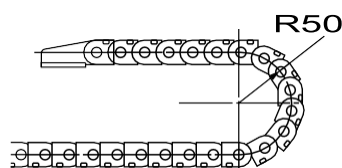

**10. Confirm wiring insulation.**

Insulation failure (interference with other circuits, poor insulation between terminals, etc.) could introduce excessive voltage or current to the controller or its peripheral devices, causing damage to them.

**11. The speed and force may change depending on the cable length, load, and mounting conditions.**

Furthermore, if the cable length exceeds 5 m, then it will decrease by up to 10% for every additional 5 m. (At 15 m: Reduced by up to 20%)

**12. When checking the conductivity of the cable, be careful not to deform the connector's mating hole and terminals.**

Inserting a non-compatible connector, tool, cylinder-shaped object, etc., into the connector's mating hole can cause the mating hole or terminals to become deformed, which may cause contact failure or disconnection.

**13. Refrain from plugging in and unplugging the connector frequently.**

Doing so may result in contact failure or disconnection.

## **【Transportation】**

 **Caution**

- 1. Do not carry or swing the product by the cable.**

## **2.2 Design/Selection**

 **Warning**

- 1. Be sure to read the operation manual (this manual and the one for the controller: LEC series).**  
Handling or usage/operation other than that specified in the operation manual may lead to breakage or operation failure of the product. Any damage attributed to use beyond the specifications is not covered by the warranty.
- 2. There is a possibility of dangerous sudden action by the product if the sliding parts of the machinery are twisted due to external forces, etc.**  
In such cases, human injury may occur, such as by hands or feet getting caught in the machinery, or damage to the machinery itself may occur. Design the machinery so as to avoid such dangers.
- 3. A protective cover is recommended to minimize the risk of personal injury.**  
If a driven object and the moving parts of the product are in close proximity, personal injury may occur. Design the system to avoid contact with the human body.
- 4. Securely tighten all stationary parts and connected parts so that they will not become loose.**  
When the product operates with high frequency or is installed where there is a lot of vibration, ensure that all parts remain secure.
- 5. Consider a possible loss of power source.**  
Take measures to prevent injury and equipment damage in the event of a power source failure.
- 6. Consider emergency stops.**  
Design so that human injury and/or damage to machinery and equipment will not be caused when machinery is stopped by a safety device under abnormal conditions, such as a power outage or a manual emergency stop.
- 7. Consider the whole system.**  
Design the system so that human injury or equipment damage will not occur upon the restart of operation of the whole system.

8. **Never disassemble the product or make any modifications, including additional machining.**  
Doing so may cause human injury and/or an accident. It may also cause the deterioration of the product's performance.
9. **Do not use the stop signals, the "EMG" of the controller and the stop switch on the teaching box, as the emergency stop of the system.**  
The stop signals, "EMG" of the controller and the stop switch on the teaching box, are for decelerating and stopping the actuator. Design the system with an emergency stop circuit which applies to the relevant safety standards separately.
10. **When using the product vertically for applications, it is necessary to install a built-in safety device.**  
The table may fall due to the weight of a workpiece. The safety device should not interfere with the normal operation of the machine.



### **Caution**

1. **Operate within the limits of the maximum usable stroke.**  
The product will be damaged if it is used with a stroke which exceeds the maximum stroke. Refer to the specifications of the product.
2. **When the product repeatedly cycles with partial strokes, operate it at a full stroke at least once a day or every 1000 strokes.**  
Otherwise, lubrication may run out.
3. **Do not use the product in applications where excessive external force or impact force is applied to it.**  
The product can be damaged. The components, including the motor, are manufactured to precise tolerances. Even a slight deformation may cause a malfunction or seizure.
4. **During operation (positioning operation or pushing operation), it cannot be returned to the origin position.**
5. **Refer to the Auto Switches Precautions (pages 15 to 19) if an auto switch is to be built in and used.**
6. **Step motor (servo/24 VDC) and servo motor (24 VDC) specifications with the following model number are not compliant with UL Standards: "Controller/Driver type: Without controller/driver (Nil)."**  
Individual actuators are not certified as UL Standards compliant products.
7. **When UL Standards compliance is required, the electric actuator and controller/driver should be used with a UL1310 class 2 power supply.**
8. **Do not exceed the product specifications even if a work load is supported by external guides.**  
Although the actuator moment is reduced by external guides, the required transport ability (the relationship between the speed and the work load) is not reduced.

## **2.3 Mounting**



### **Warning**

1. **Keep the manual in a safe place for future reference.**  
The product should be mounted and operated only after thoroughly reading the operation manual and understanding its contents.
2. **Observe the tightening torque for screws.**  
Tighten the screws to the recommended torque for mounting the product.
3. **Do not make any alterations to this product.**  
Alterations made to this product may lead to a loss of durability or damage to the product, which can lead to human injury or damage to other equipment and machinery.

4. **When connecting, make sure the rod axis and the load, and the direction of the movement match.**  
Failure to do so may cause complications with the lead screw, such as wear or damage.
5. **When an external guide is used, connect the moving parts of the actuator and the load in such a way that there is no interference at any point within the stroke.**  
Do not scratch or dent the sliding parts of the product tube, piston rod, etc., by striking or grasping them with other objects. The components are manufactured to precise tolerances. Even a slight deformation may cause a malfunction or seizure.
6. **Prevent the seizure of rotating parts (pins, etc.) by applying grease.**
7. **Do not use the product until you confirm that the equipment can operate properly.**  
After mounting or repair, connect the power supply to the product and perform appropriate functional inspections to check it is mounted properly.
8. **When one side is fixed**  
When an actuator is operated at a high speed with one end fixed and the other free (basic, flange, or direct mount types), a bending moment may act on the actuator due to the vibration generated at the stroke end, which can damage the actuator. In such a case, install a mounting bracket to suppress the vibration of the actuator body, or reduce the speed so that the actuator does not vibrate. Also, use a mounting bracket when moving the actuator body or when a long stroke actuator is mounted horizontally and fixed at one end.
9. **Do not apply strong impact or an excessive moment while mounting the product or a workpiece.**  
If an external force over the allowable moment is applied, it may cause play in the guide or an increase in the sliding resistance.
10. **Maintenance space**  
Reserve sufficient space for maintenance.

## 2.4 Handling



### Warning

1. **Do not touch the motor during operation.**  
The surface temperature of the motor can increase to approx. 80°C due to operating conditions. The temperature may also increase due to energization. As it may cause burns, do not touch the motor when in operation.
2. **If abnormal heating, smoking, fire, etc., occurs in the product, immediately shut off the power supply.**
3. **Stop operation at once if there are abnormal noises or vibrations.**  
Abnormal noises or vibrations may mean that the product is not properly mounted, and if allowed to continue in this state, damage to the equipment may occur.
4. **Never touch the rotating parts of the motor while in operation.**
5. **Before installing, adjusting, inspecting, or performing maintenance on the product, controller, and related equipment, be sure to shut off the power supply. Then, lock it so that no one other than the person working can turn the power on, or implement measures such as a safety plug.**
6. **In the case of an actuator that has a servo motor (24 VDC), the motor phase detection step is conducted by inputting the servo's on signal just after the controller power is turned on. The motor phase detection step moves the table/rod the distance of the one screw-lead as the maximum.**  
(The motor rotates in the reverse direction if the table/rod hits an obstacle such as the end stop damper.) Take the motor phase detection step into consideration when installing and operating this actuator.



## Caution

- 1. Keep the controller and the actuator combined as delivered for use.**  
The actuator's parameters are set at the time of shipment. If it is combined with a different set of parameters, failure can result.
- 2. Conduct the following inspection before operation.**
  - a) Confirm that the power supply line and each signal line is not damaged.
  - b) Confirm that the power supply line and each signal line is not loosened.
  - c) Confirm that the electric actuator/cylinder/controller/driver is not mounted loosely.
  - d) Confirm that the electric actuator/cylinder/controller/driver is operating correctly.
  - e) Confirm the function of the emergency stop of the whole system.
- 3. If several persons are to be working conjointly, determine the procedure, signs, measures against abnormality, and restarting measures in advance. Then, have someone else, supervise the work.**
- 4. The product may operate at a speed different from the set speed depending on the load and resistance.**  
When selecting a product, check the catalog for instructions regarding selection and specifications.
- 5. Do not apply a load, impact, or resistance in addition to the transferred load during the return to origin.**  
If the product is made to return to origin by pushing force, a displacement of the origin position may occur.
- 6. Do not remove the name plate.**
- 7. Operation tests should be done at a low speed. Start operation by predefined speed after confirming there are no problems.**
- 8. Do not apply forces of impact, collision, or resistance to the moving parts of an actuator in operation.**  
Doing so will cause a decrease in product life, damage to the product, etc.

## 【Grounding】



### Warning

- 1. Be certain to ground the actuator.**
- 2. Dedicated grounding should be used.**  
Grounding should be to a D-class ground. (Ground resistance of 100  $\Omega$  or less.)
- 3. Grounding should be performed near the actuator to shorten the grounding distance.**
- 4. The cross-sectional area of this wire shall be a minimum of 2 mm<sup>2</sup>.**
- 5. Avoid common grounding with other devices.**

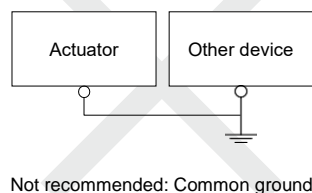
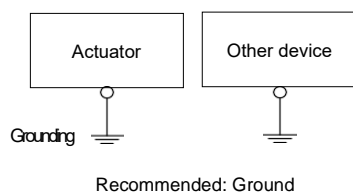

## 【Unpackaging】

### Caution

1. **Check that the received product is as ordered.**  
If a product different from the one ordered is installed, injury or damage can result.

## 2.5 Operating Environment

### Warning

1. **Avoid use in the following environments.**
  - a) Areas with large amounts of dust or cutting chips that could enter the product
  - b) Areas where the ambient temperature exceeds the specified range (Refer to the specifications.)
  - c) Areas where the ambient humidity exceeds the specified range (Refer to the specifications.)
  - d) Areas with corrosive gas, flammable gas, sea water, water, or steam that could adhere to the product
  - e) Areas where strong magnetic or electric fields are generated
  - f) Areas where direct vibration or impact shock is applied to the product
  - g) Areas where there are large amounts of dust or there is exposure to water/oil droplets
  - h) Areas that are exposed to direct sunlight (ultraviolet rays)
  - i) Areas at altitudes of over 1000 m  
Heat radiation performance and withstand voltage may decline as a result. For details, consult with SMC.
2. **Do not use in an environment where the product is directly exposed to liquid, such as cutting oils.**  
If cutting oil, coolant, or oil mist adheres to the product, failure or increased sliding resistance can result.
3. **Install a protective cover when the product is used in an environment directly exposed to foreign matters, such as dust, cutting chips, and spatter.**  
Looseness or increased sliding resistance can result.
4. **Shade the product from direct sunlight.**
5. **In locations near heat sources, block them off.**  
When there is a heat source surrounding the product, the radiated heat from the heat source can increase the temperature of the product beyond the operating temperature range. Protect it with a cover, etc.
6. **Levels of the base oil of grease may decrease due to the external environment and operating conditions, causing a decline in lubrication performance and a shortened life of the product.**

## 【Storage】

### Warning

1. **Do not store the product in a place in direct contact with rain or water drops or where it is exposed to harmful gas or liquid.**
2. **Store in an area that is shaded from direct sunlight and has a temperature and humidity within the specified range (−10°C to 60°C and 35 to 85% no condensation or freezing).**
3. **Do not apply vibration or impact to the product during storage.**

## 2.6 Maintenance

### Warning

1. **Do not disassemble or repair the product.**  
Fire or electric shock can result. Contact SMC if the disassembly of the product is required for maintenance.

2. **Before modifying or checking the wiring, the voltage should be checked with a tester 5 minutes after the power supply has been turned off.**

Failure to do so may result in electrical shock.

 **Caution**

1. **Perform maintenance and inspection according to the procedures indicated in the operation manual.**

Improper handling can cause an injury, damage, or the malfunction of equipment and machinery.

2. **Removal of equipment**

Before equipment is removed, first confirm that measures are in place to prevent the dropping or runaway of driven objects, etc. Proceed only after cutting off the electric power. When starting up again, proceed with caution after confirming that conditions are safe.

3. **Be sure to cut the power to the controller and disconnect the electric actuator cable before moving the electric actuator slider manually by hand.**

If the slider is moved with the electric actuator and controller still connected, the induced voltage of the motor will go to the controller, making it difficult to move the electric actuator smoothly. Moreover, frequently moving the electric actuator slider may result in controller damage or malfunction due to the induced voltage.

## **【Lubrication】**

 **Caution**

1. **The product has been lubricated for life by the manufacturer and does not require any further lubrication.**

When lubrication is applied, special grease must be used. Please read the maintenance manual of each actuator.

## **2.7 Actuator with Lock**

 **Warning**

1. **Do not use the lock as a safety brake or as a control that requires a locking force.**

The lock used for the product with lock is designed to prevent the dropping of workpieces.

2. **For vertical mounting, use the product with lock.**

If the product is not equipped with a lock, the product will move and drop the workpiece when the power is removed. Please ensure that your safe equipment designs include measures to prevent the falling of workpieces.

3. **“Drop prevention” is a safety precaution that prevents a workpiece from dropping due to its weight when the product operation is stopped and the power supply is turned off.**

4. **Do not apply an impact load or strong vibration while the lock is activated.**

If an external impact load or strong vibration is applied to the product, the lock will lose its holding force and damage to the sliding parts of the lock or a reduced service life may result. The same adverse effects may also occur when the lock slips due to a force exceeding the holding force, as this accelerates the wear of the lock.

5. **Do not apply liquid, oil, or grease to the lock or the area surrounding it.**

When liquid, oil, or grease are adhered to the sliding parts of the lock, its holding force will reduce significantly. Any changes in lock sliding performance and condition may cause a lock release malfunction.

6. **Take measures against drops and check that safety is assured before the mounting, adjustment, and inspection of the product.**

If the lock is released with the product mounted vertically, a workpiece can drop due to its weight.



7. **When the actuator is operated manually (when the SVRE output signal is off), supply 24 VDC to the [BK RLS] terminal of the power supply connector.**

If the product is operated without releasing the lock, the wearing of the lock sliding surface will be accelerated, causing a reduction in the holding force and the life of the locking mechanism.

8. **Do not supply 24 VDC power supply continuously to the [BK RLS (Lock release)] terminal.**

Stop supplying 24 VDC power supply to the [BK RLS (Lock release) terminal during normal operation. If power is supplied to the [BK RLS] terminal continuously, the lock will be released, and workpieces may be dropped when the stop signal (EMG) is received.

9. **The actuator may unable to unlock when the sliding part for locking reaches its life due to the rotation sliding of the shoe during operation. When the lock mechanism reaches its life, please contact SMC sales office for the replacement parts.**

The sliding part for locking may make noise during operation, but this is normal.

## 2.8 Design/Selection

### Warning

1. **Be sure to apply the specified voltage.**

Otherwise, malfunction or breakage may occur. If the applied voltage is lower than the specified voltage, it is possible that the load will not be able to be moved due to an internal voltage drop of the controller. Please check the operating voltage before use.

2. **Do not operate the product beyond the specifications.**

Otherwise, a fire, malfunction, or actuator damage may result. Please check the specifications before use. Install an emergency stop circuit.

3. **Please install an emergency stop outside of the enclosure so that the system operation can be stopped immediately and the power supply can be intercepted.**

4. **In order to prevent any damage caused by the breakdown or malfunction of the controller and its peripheral devices, a backup system should be established in advance by giving a multi-layered structure or a fail-safe design to the equipment, etc.**

5. **If a danger of human injury is expected due to abnormal heat generation, smoking, ignition, etc., of the controller and its peripheral devices, cut off the power supply of the product and the system immediately.**

### Caution

1. **Use an actuator with the lock option if the actuator will not be mounted horizontally for use.**

Burnout of the internal parts of the controller may occur. If the actuator is not equipped with a lock, it will move and drop the workpiece when the power and servo are turned OFF.

## 2.9 Handling

### Warning

1. **Do not touch the inside of the controller and its peripheral devices.**

Doing so may cause an electric shock or damage to the controller.

2. **Do not perform the operation or setting of the product with wet hands.**

Doing so may cause an electric shock.

3. **Products with damage or those missing any components should not be used.**

An electric shock, fire, or injury may result.

4. **Use only the specified combination between the electric actuator and controller.**

Failure to do so may cause damage to the actuator or the controller.

5. **Be careful not to be hit by workpieces while the actuator is moving.**

It may cause an injury.

6. **Do not connect the power supply or power on the product before confirming the area to which the work-piece moves is safe.**  
The movement of the workpiece may cause an accident.
7. **Do not touch the product when it is energized and for some time after power has been disconnected, as it is very hot.**  
Doing so may lead to a burn due to the high temperature.
8. **Before installation, wiring, and maintenance, the voltage should be checked with a tester 5 minutes after the power supply has been turned off.**  
Otherwise, an electric shock, fire, or injury may result.
9. **Static electricity may cause malfunction or break the controller. Do not touch the controller while power is supplied.**  
When touching the controller for maintenance, take sufficient measures to eliminate static electricity.
10. **Do not use the product in an area where dust, powder dust, water, chemicals, or oil is in the air.**  
It will cause failure or malfunction.
11. **Do not use the product in an area where a magnetic field is generated.**  
It will cause failure or malfunction.
12. **Do not install the product in an environment containing flammable gas, explosive gas, or corrosive gas.**  
It could lead to fire, explosion, or corrosion.
13. **Radiant heat from strong heat sources, such as a furnace, direct sunlight, etc., should not be applied to the product.**  
It will cause failure of the controller or its peripheral devices.
14. **Do not use the product in an environment subject to a temperature cycle.**  
It will cause failure of the controller or its peripheral devices.
15. **Do not use the product in a place where surges are generated.**  
When there are units that generate a large amount of surge around the product (e.g. solenoid type lifters, high-frequency induction furnaces, motors, etc.), this may cause deterioration or damage to the product's internal circuit. Avoid sources of surge generation and crossed lines.
16. **Do not install the product in an environment under the effect of vibrations and impacts.**  
It will cause failure or malfunction.
17. **When a surge-generating load, such as a relay or solenoid valve, is driven directly, use a product that incorporates a surge absorption element.**
18. **The power supplies should be separated between the controller power and the I/O signal power, and both power supplies must not be of the "inrush-current limited" type.**  
If the power supply is of the "inrush-current limited" type, a voltage drop may occur during the acceleration or deceleration of the actuator.

## 2.10 Mounting

### Warning

1. **Install the controller and its peripheral devices on a fire-proof material.**  
Direct installation on or near a flammable material may cause a fire.
2. **Do not install the product in a place subject to vibrations and impacts.**  
It will cause failure or malfunction.
3. **Do not mount the controller and its peripheral devices together with a large-sized electromagnetic contactor or no-fuse breaker, which generate vibration, on the same panel. Mount them on different panels, or keep the controller and its peripheral devices away from such a vibration source.**

- 4. Install the controller and its peripheral devices on a flat surface.**  
If the mounting surface is distorted or uneven, an unacceptable force may be added to the housing, etc., causing problems.
- 5. Take measures to ensure that the operating temperatures of the controller and its peripheral devices are within the range of the specifications. Also, the controller should be installed with spaces between its sides and the other structures or components.**  
Failure to do so may cause the malfunction of the controller and its peripheral devices or a fire.

## 2.11 Power Supply



### Caution

- 1. Use a power supply that has low noise between lines and between the power and ground.**  
In cases where noise is high, an isolation transformer should be used.
- 2. To prevent lightning surges, appropriate measures should be taken. Ground the surge absorber for lightning separately from the grounding of the controller and its peripheral devices.**

## 2.12 Grounding



### Warning

- 1. Be sure to carry out grounding in order to ensure the noise tolerance.**
- 2. Dedicated grounding should be used.**  
Grounding should be to a D-class ground. (Ground resistance of 100  $\Omega$  or less)
- 3. Grounding should be performed near the controller and its peripheral devices to shorten the grounding distance.**
- 4. In the unlikely event that a malfunction is caused by the ground, please disconnect it.**

## 2.13 Wiring



### Warning

- 1. Do not apply any excessive force to cables, such as repeated bending, tensioning, or placing a heavy object on the cables.**  
It may cause an electric shock, fire, or the breaking of a wire.
- 2. Connect wires and cables correctly.**  
Incorrect wiring could break the controller or its peripheral devices depending on the seriousness.
- 3. Do not connect wires while power is being supplied.**  
It may cause the controller to break or its peripheral devices could be damaged, causing a malfunction.
- 4. Do not carry the product by holding its cables.**  
It may cause an injury or damage to the product.
- 5. Do not connect power or high-voltage cables in the same wiring path as the unit.**  
The product can malfunction due to noise and surge voltage interference in the signal line from the power and high-voltage cables. Separate the wiring of the controller and its peripheral devices from that of the power and high-voltage cables.
- 6. Confirm wiring insulation.**  
Insulation failure (interference with other circuits, poor insulation between terminals, etc.) could introduce excessive voltage or current to the controller or its peripheral devices and damage them.

## 2.14 Maintenance

### Warning

- 1. Perform a maintenance and inspection periodically.**  
Confirm wiring and screws are not loose. Loose screws or wires may cause unintentional malfunction.
- 2. Conduct an appropriate functional inspection after completing the maintenance and inspection.**  
At times where the equipment or machinery does not operate properly, conduct an emergency stop of the system. Otherwise, an unexpected malfunction may occur and it will become impossible to ensure safety. Conduct a test of the emergency stop in order to confirm the safety of the equipment.
- 3. Do not disassemble, modify, or repair the controller and its peripheral devices.**
- 4. Do not put anything conductive or flammable inside of the controller.**  
It may cause a fire.
- 5. Do not conduct an insulation resistance test or with-stand voltage test on this product.**
- 6. Ensure sufficient space for maintenance activities.**  
Design the system allowing the required space for maintenance and inspection.

### 3. LEKFS series slider type / Common precautions

#### 3.1 Design / selection

##### Warning

- 1. Do not apply a load in excess of the actuator specification.**  
A product should be selected based on the maximum work load and allowable moment.  
If the product is used outside of the operating specification, eccentric load applied to the guide will become excessive and have adverse effects such as creating play in the guide, reduced accuracy and reduced product life.
- 2. Do not exceed the speed limit of the actuator specification.**  
Select a suitable actuator by the relationship of allowable work load and speed.  
Noise or reduction of accuracy may occur if the actuator is operated in excess of its specification and could lead to reduced accuracy and reduced product life.
- 3. Do not use the product in applications where excessive external force or impact force is applied to it.**  
This can lead to premature failure of the product.
- 4. When the product repeatedly cycles with partial strokes (see the table below), operate it at a full stroke at least once every 10 strokes.**  
Otherwise, lubrication can run out.

Model	Partial stroke
LEKFS16	50mm or less
LEKFS25	65mm or less
LEKFS32	70mm or less
LEKFS40	105mm or less

- 5. Actuator sizing is necessary with the total workload including the external force if external force is added on the actuator table.**  
When mounting cable-duct to actuator, the resistance of actuator table may increase. It causes an overload alarm, so pay attention to the resistance.

#### 3.2 Handling

##### Caution

##### 1. INP output signal

###### 1) Positioning operation

When the product comes within the set range by step data [In position], output signal will be turned on. Set to [0.50] for LEFS and [1] for LEFB, or higher.

##### 2. Never allow the table to collide with the stroke end except during return to origin.

When incorrect instructions are inputted, such as those which cause the product to operate outside of the specification limits or outside of the actual stroke through changes in the controller/driver settings and/or origin position, the table may collide with the stroke end of the actuator. Be sure to check these points before use. If the table collides with the stroke end of the actuator, the guide, belt, or internal stopper may break. This can result in abnormal operation.

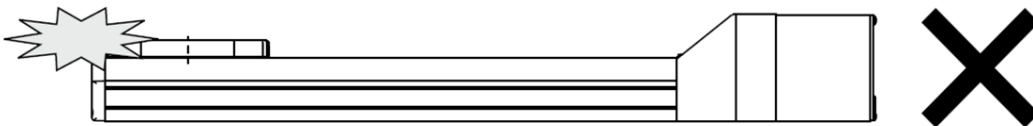

Handle the actuator with care when it is used in the vertical direction as the workpiece will fall freely from its own weight.

- 3. Do not change the positioning force from initial setting.**  
If the positioning force is changed, it may cause a decrease in performance.
- 4. Do not operate by fixing the table and moving the actuator body.**  
An excessive load will be applied to the table, which could lead to damage to the actuator and reduced accuracy and reduced product life.
- 5. Check the specification for the minimum speed of each actuator.**
- 6. The actual speed of this actuator is affected by the work load and stroke.**  
Check the model selection section of the catalog
- 7. Do not apply load or impact or resistance in addition to the transferred during return to origin.**

8. Do not scratch or cause other damage to the body and table mounting surfaces.
9. Do not hit the table with the workpiece in the positioning operation and positioning range.
10. There is a type where grease is applied to the dust seal band for sliding. When wiping off the grease remove foreign matter, etc., be sure to apply grease again.
11. For bottom mounting, the dust seal band may be deflected.

### 3.3 Mounting

#### ⚠ Caution

1. **Keep the flatness of mounting surface to within [0.1mm or less for length 500mm].**  
Insufficient flatness of the work piece or the surface onto which the actuator body is to be mounted can cause play in the guide and increased sliding resistance.
2. **When mounting the workpiece or other device to the actuator tighten the fixing screws with adequate torque within the specified torque range.**  
Tightening the screws with a higher torque than the maximum may cause malfunction, whilst tightening with a lower torque can cause the displacement of the mounting position or in extreme conditions detaching of the work piece.

Work piece mounting

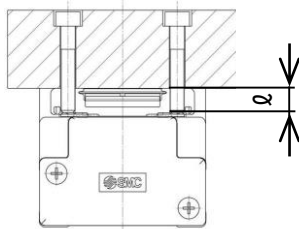

Model	Bolt size	Maximum tightening torque [Nm]	ℓ (Maximum thread depth [mm])
LEKFS16	M4x0.7	1.5	6
LEKFS25	M5x0.8	3.0	8
LEKFS32	M6x1	5.2	9
LEKFS40	M8x1.25	12.5	13

Use screws with adequate length, but with length less than the maximum thread depth. The use of screws that are too long can touch the body and cause malfunction.

3. **When mounting the actuator, use screws with adequate length and tighten them to the adequate torque. And use all mounting holes to maintain the catalogue performance.**  
Tightening the screws with a higher torque than recommended may cause malfunction, whilst the tightening with lower torque can cause the displacement of mounting position or in extreme conditions the actuator could become detached from its mounting position.

Actuator mounting

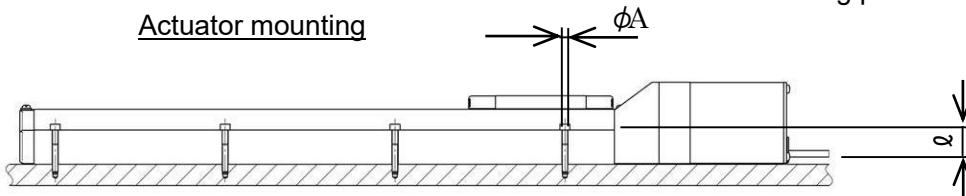

Model	Bolt size	Maximum tightening torque [Nm]	φA (mm)	ℓ (mm)
LEKFS16	M3	0.63	3.5	23.5
LEKFS25	M4	1.5	4.5	24
LEKFS32	M5	3.0	5.5	30
LEKFS40	M6	5.2	6.6	31

4. **When mounting the actuator, leave a gap of 40mm or more to allow for bending of the actuator cable.**

### 3.4 Precaution on maintenance

#### ⚠ Warning

1. Turn off the power supply before maintenance and replacement of the product.
2. Put on protective goggles when applying grease.

#### [Maintenance frequency]

Perform maintenance according to the table below. Contact SMC if any abnormality is found.

Frequency	Appearance check	Internal check	Belt check
Inspection before daily operation	○	/	/
Inspection every six months / 1000km / 5million cycle *	○	○	○

\*Whichever occurs first.

#### [Items for visual appearance check]

1. Loose screws. Abnormal dirt.
2. Check of flaws/faults and cable connections.
3. Vibration, noise.

#### [Items for internal check]

1. Lubricant condition on moving parts.
2. Loose or mechanical play in fixed parts or fixing screws.

#### [Items for belt check]

Check the belt regularly as shown in “maintenance frequency”.

Stop operation immediately and contact SMC when the belt appears to be like photographs shown below.

#### a. Tooth shape canvas is worn out

Canvas fiber becomes fuzzy.

Rubber is removed and the fiber becomes whitish.

Lines of fibers become unclear.

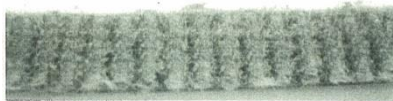

Teeth become fuzzy

#### b. Peeling off or wearing of the side of the belt

Belt corner becomes round and frayed thread sticks out.



#### c. Belt partially cut

Belt is partially cut. Foreign matter caught in teeth other than cut part causes flaw.

#### d. Vertical line of belt teeth

Flaw, which is made when the belt runs on the flange.

#### e. Rubber back of the belt is softened and sticky.

#### f. Crack on the back of the belt

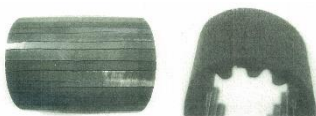

### 3.5 How to detach and attach the dust seal band

For the internal-check as the maintenance, the method of detaching and attaching the dust seal band is shown as the following.

#### <Dis-assembly>

1. Loosen the fixing bolts of end side of the “Band holder”.

(The picture shows LEFB, but LEKFS is same instruction as LEFB.)

Pay attention to not cut hand on the edges of the "Dust seal band".

Note: The "Dust seal band" can only be removed by loosening the "Band holder" bolts.

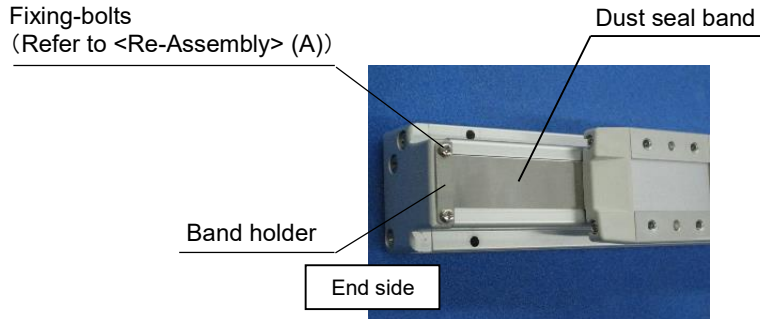

2. Remove the “Seal band holder” and the “plate” as shown.

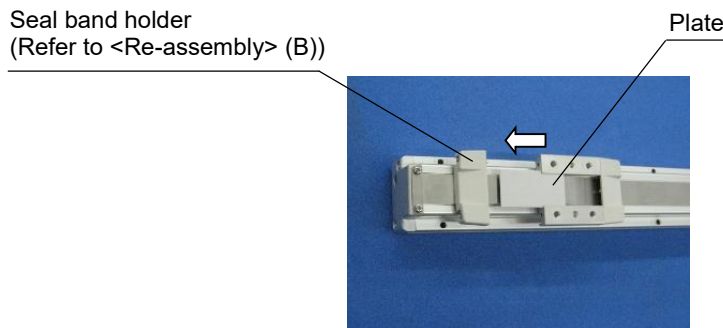

3. Loosen the fixing bolts of motor side of the “Band holder” and then remove the “Dust seal band”.

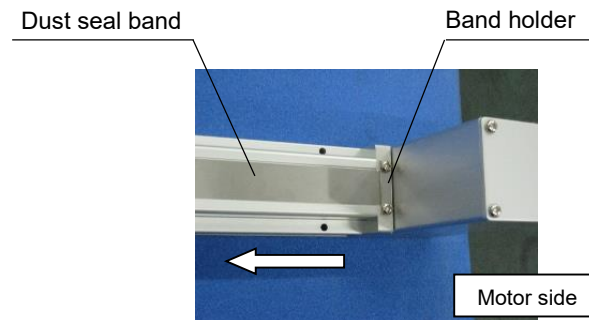

#### <Re-assembly>

The re-assembly is completed by the reverse procedure of “Dis-assembly” sections 1, 2 and 3.

(A)

Model	Type of bolt	Bolt size	Tightening torque [Nm]
LEKFS16	Round head combination screw	M3x6	0.63±10%
LEKFS25		M3x6	
LEKFS32		M3x6	
LEKFS40		M3x6	

(B)

Model	Type of bolt	Bolt size	Tightening torque [Nm]
LEKFS16	Cross recessed round head screw	M2.5x12	0.36±10%
LEKFS25		M3x20	0.63±10%
LEKFS32		M4x30	0.76±10%
LEKFS40		M4x35	



### 3.6 Replacement of belt

1. After Bolt is removed, "Pulley plate" is removed.

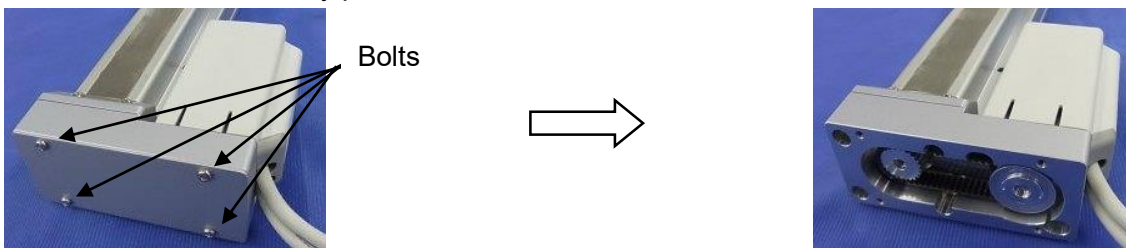

2. "Motor cover" and "Grommet" are removed. (Only "With motor cover")

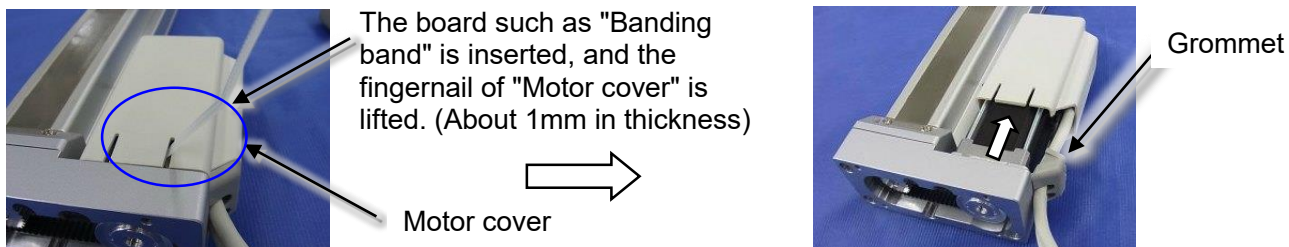

3. The bolt that is the fixation of "Motor" is loosened (To extent in which the slide can be done), and "Bearing support" is removed, and "Belt" is removed.

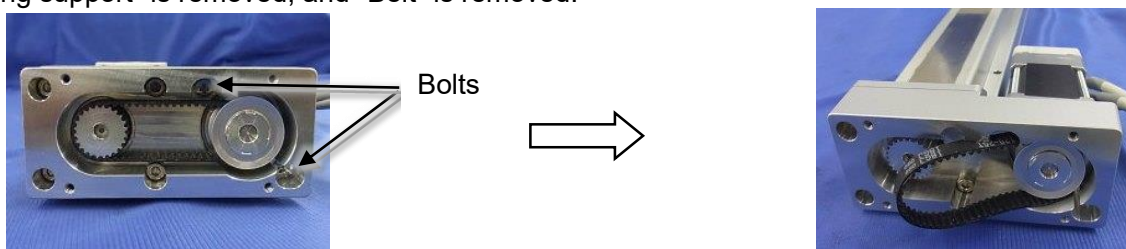

4. After "Belt" is installed, and the bearing support is obtained, the root of "Motor" is pulled in a string or a long banding band. With tensile force adjusted, tighten the bolts which fix the actuator to the motor. (See the table below)

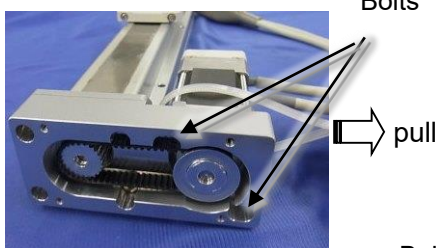

Bolts Refer to <Re-assembly> (B)

Model	Belt Part number	Pull tension (N)
LEKFS16	LE-D-6-5	9.8
LEKFS25	LE-D-6-2	19.6
LEKFS32	LE-D-6-3	49.0
LEKFS40	LE-D-6-4	98.1

5. "Pulley plate" is installed.



Bolts Refer to <Re-assembly> (A)

Model	Type of bolt	Bolt size	Tightening torque [Nm]
LEKFS16	Round head combination screw	M2.5x5	0.36±10%
LEKFS25		M3x6	0.63±10%
LEKFS32		M3x6	
LEKFS40		M3x6	

(B)

Model	Type of bolt	Bolt size	Tightening torque [Nm]
LEKFS16	Cross recessed round head screw with washer	M2.5x7(without lock)	0.36±10%
	Cross recessed binding head screw	M2.6x10(with lock)	
LEKFS25	Cross recessed binding head screw	M3x6(without lock) M3x8(with lock)	0.63±10%
LEKFS32		M4x14(without lock) M4x60(with lock)	1.5±10%
LEKFS40	Cross recessed round head screw with washer	M4x14(without lock) M4x60(with lock)	

## 4. Troubleshooting

Alarms below are abstract of representative examples.



For other alarms, see operation manual of controller.

No.	Phenomenon	Cause	Countermeasure
1	Fail to operate / Initial stage	1) The cable is not connected or has been disconnected.	Check if the cable is properly installed / /See 2.1 Wiring / cables on p. 8
	When power is supplied, alarm for "Phase Det ALM /code: 1-193" is generated. ↓ <Procedure of restart> "Turn the power supply off." ↓ "Turn the power supply on"	2) The load/resistance being applied to the actuator constantly exceeds the actuators specification.	Keep load and resistance within specification range. Check the actuator mounting condition or check if external force adds the resistance of actuator table by using movable cable-duct. /See 1.2 Specifications on p.5
		3) The combination of the controller and actuator is not correct.	The controller and the actuator combination at the time of shipment should not be changed. /See 2.9 ⚠Warning (4) on p.15
		4) Excessive external force is being applied, (including vibration) or impact load.	Operate within the specified range. /See 1.2 Specifications on p.5
	Alarm for "Step data ALM1/code:1-048" is generated ↓ <Procedure of restart> Input the "RESET" signal.	Setting condition for step data is not correct. < Correct set condition > (1)Area 1 < Area 2	Review the content of step data. / Refer to the JXC controller operation manual.
Alarm for "Servo off ALM/code: 1-098" is generated ↓ <Procedure of restart> Input the "RESET" signal.	Perform the "Return to origin", the positioning operation and JOG operation during the "SVON": OFF.	Provide the operation instruction after confirming that the input signal [SVON] is ON and then the output signal [SVRE] is ON.	
Alarm for "Drive ALM/code: 1-099" is generated. ↓ <Procedure of restart> Input the "RESET" signal.	Perform positioning operation before the "return to origin".	Provide the operation instruction after confirming that the input signal [SETUP] is ON and then the output signal [SETON] is ON.	

No.	Phenomenon	Cause	Countermeasure
2	Operation not completed / Operation continue  Alarm for "Over load/code: 1-148" or "Posn failed/code: 1-149" is generated.	1) Added excessive external force (including vibration) or impact load.	Operate within the specified range. /See 1.2 Specifications on p.5
		2) The Power supply does not have sufficient capacity.	Check the power consumption for each actuator and controller: If necessary replace the existing power supply with a power supply with sufficient capacity. /See 1.2 Specifications on p.5
		3) Load/resistance more than specified range is being applied to the actuator.	Use within specification range. Check the actuator mounting condition or check if external force adds the resistance of actuator table by using movable cable-duct. /See 1.2 Specifications on p.5
		4) Pushing operation is performed at "Positioning operation"	Review the content of the step data.
		5) The cable is not connected or has been disconnected.	Confirm that the cable is connected correctly. /See 2.1 Wiring / cables on p.8
		6) It was not the intended origin position because the actuator pinched the work-piece during the "return to origin".	Remove the work-piece and restart the return to the intended origin position.
		7) Actuator mouting condition is not good.	Check the actuator mounting surface. Keep the flatness of mounting surace to within 0.1mm or less.
		8) Wrong input [0] is input as the positioning force.	Check the step data.<Moving force> / Refer to the JXC controller operation manual.
		9) The step data position is not changed correctly after the return to origin direction is changed.	Check the step data.<Position> / Refer to the JXC controller operation manual.
		10) Because the operation of the step data is set to [INC/relative], the table comes into contact with an external object and does not move due to continuous operation.	Check the step data.<Position> / Refer to the JXC controller operation manual.
Operation not completed / Operation continue Alarm for "Stroke limit/code: 1-052" is generated.  ↓ <Procedure of restart> Input the "RESET" signal.	1) Moving distance exceeds the "Stroke(+)" / "Stroke(-)".	Check the value of the "Position" of step data and the value of the "Stroke(+)" / "Stroke(-)" of the basic parameter. /Refer to the JXC controller operation manual.	

No.	Phenomenon	Cause	Countermeasure
2	Operation not completed / Operation continue Alarm for "Over motor Vol /code: 1-145" is generated.	1) If the power supply is an "inrush-current restraining type", the alarm may be generated due to voltage drop.	Replace the power supply with a non "inrush-current restraining type" power supply. /Refer to the JXC controller operation manual.
		2) The Power supply does not have sufficient capacity.	Check the power consumption for each actuator and controller: If necessary replace the existing power supply with a power supply with sufficient capacity. /See 1.2 Specifications on p.5
		3) Load/resistance more than specified range is being applied to the actuator.	Use within specification range. Check the actuator mounting condition or check if external force adds the resistance of actuator table by using movable cable-duct. /See 1.2 Specifications on p.5
	Alarm for "Err overflow/code: 1-196" is generated. ↓ <Procedure of restart> "Turn the power supply off." ↓ "Turn the power supply on"	1) Added excessive external force (including vibration) or impact load.	Operate within the specified range. /See 1.2 Specifications on p.5
		2) The Power supply does not have sufficient capacity.	Check the power consumption for each actuator and controller: If necessary replace the existing power supply with a power supply with sufficient capacity. /See 1.2 Specifications on p.5
		3) Load/resistance more than specified range is being applied to the actuator.	Use within specification range. Check the actuator mounting condition or check if external force adds the resistance of actuator table by using movable cable-duct. /See 1.2 Specifications on p.5
		4) The pushing operation is performed at the "Positioning operation position"	Review the content of the step data.
		5) The cable is not connected or has been disconnected.	Confirm that the cable is connected correctly. /See 2.1 Wiring /cables on p.8

No.	Phenomenon	Cause	Countermeasure
		6) It was not the intended origin position because the actuator pinched the work-piece during the "return to origin".	Remove the work-piece and restart the return to the intended origin position.
		7) Wrong input [0] is input as the positioning force.	Check the step data. <Moving force>
		8) The step data position is not changed correctly after the return to origin direction is changed.	Check the step data. <Position>
		9) Because the operation of the step data is set to [INC/relative], the table comes into contact with an external object and does not move due to continuous operation.	Check the step data. <Position>
2	<p>Operation not completed / During operation (Not always, but may happen occasionally)</p> <p>Alarm for "Step data ALM2/code: 1-051" is generated.</p> <p style="text-align: center;">↓</p> <p style="text-align: center;">&lt;Procedure of restart&gt; Input the "reset" signal.</p>	1) Command invalid (unregistered) step data.	Check if the step data is valid (registered).
		2) Different input signal to the expected step number is inputted to the controller, because of a too short an interval between the input signal of "IN*" and the "Drive" or inputting the signals at the same time.	Add an interval of 15ms (the recommendation is 30ms) or more between the input signals. /Refer to the JXC controller operation manual.
		3) Different input signal to the expected step number is inputted to the controller, because the input signal time was too short.	Add an interval of 15ms (the recommendation is 30ms) or more between the input signals. /Refer to the JXC controller operation manual.
		4) Different input signal to the expected step number is inputted to the controller, caused by PLC or other device.	Check that the step number is inputted correctly for the required motion.
	<p>- Operation completed by unexpected motion.</p> <p>- No alarm / During operation (Not always, but may happen occasionally)</p>	1) Different input signal to the expected step number is inputted to the controller, because of a too short an interval between the input signal of the "IN*" and the "Drive" or inputting the signals at the same time.	Add an interval of 15ms (the recommendation is 30ms) or more between the input signals. /Refer to the JXC controller operation manual. Note) Recommend to check the "OUT" output signal for more secure operation.
		2) Different input signal to the expected step number is inputted to the controller, because the input signal time was too short.	Add an interval of 15ms (the recommendation is 30ms) or more between the input signals. /Refer to the JXC controller operation manual. Note) Recommend to check the "OUT" output signal for more secure operation.

No.	Phenomenon	Cause	Countermeasure
		3) Different input signal to the expected step number is inputted to the controller, caused by PLC or other device.	Check that the step number is inputted correctly for the required motion.  /Refer to the JXC controller operation manual. Note) Recommend to check the "OUT" output signal for more secure operation.
3	"INP" output signal is unstable. "INP" output signal is unstable even after the positioning operation is completed.	1) The value of [In position] in step data is too small.	Increase [In position] value as the following.  LEKFS: [0.5] or more
4	Positioning repeatability is out of specified range.	1) It shifts to the next operation by receiving the "INP" output signal.	Shift to the next operation after receiving the "BUSY" output signal is outputted.
		2) The belt is loosened.	Readjust belt tension to the appropriated value.
5	Damage	1) Abnormal external force	Interference of mechanism, eccentric load or excess load leads to cause deformation or damage of the actuator. Eliminate these factors.
6	The table of the actuator with vertical mounting vibrates repeated up and down.	1) Actuator carries excess load.	Check if the workload is within the specification range.
7	The belt driven actuator, vibration / noise occur during operation at speeds within the actuator specification.	1) Influence of character frequency	Change the speed setting to a speed that does not cause vibration.
		2) The gain tuning is not suitable.	It may need gain tuning suitable for the application. Contact SMC in this case.
8	Cannot be actuated manually or by manual override adjustment screw (does not operate). (At stop(EMG) or SVRE[OFF])	1) Contacts the stroke end of the actuator or the workpiece.	Check the stroke position and how workpieces are mounted.
		2) [Lock type] is selected	Supply 24VDC power supply to the [BK RLS] terminal of controller/CN1 power supply plug in order to unlock.  /see 2.7 Actuator with lock  Warning(7) on P14
	Lock type is selected, but workpieces are dropped during stopping(EMG) or SVRE[OFF], or moved by external force.	1) Load exceeding the maximum work load is mounted, or external force more than the lock holding force is applied.	Check the mounted load and lock holding force to confirm if they are within the operation range.  /See 1.2 Specifications on p.5
2) 24VDC is supplied to "BK RLS" terminal of controller/CN1 power supply connector.		Stop supplying 24VDC power supply to the [BK RLS] terminal  /see 2.7 Actuator with lock  Warning(8) on p15	

## Ausführung

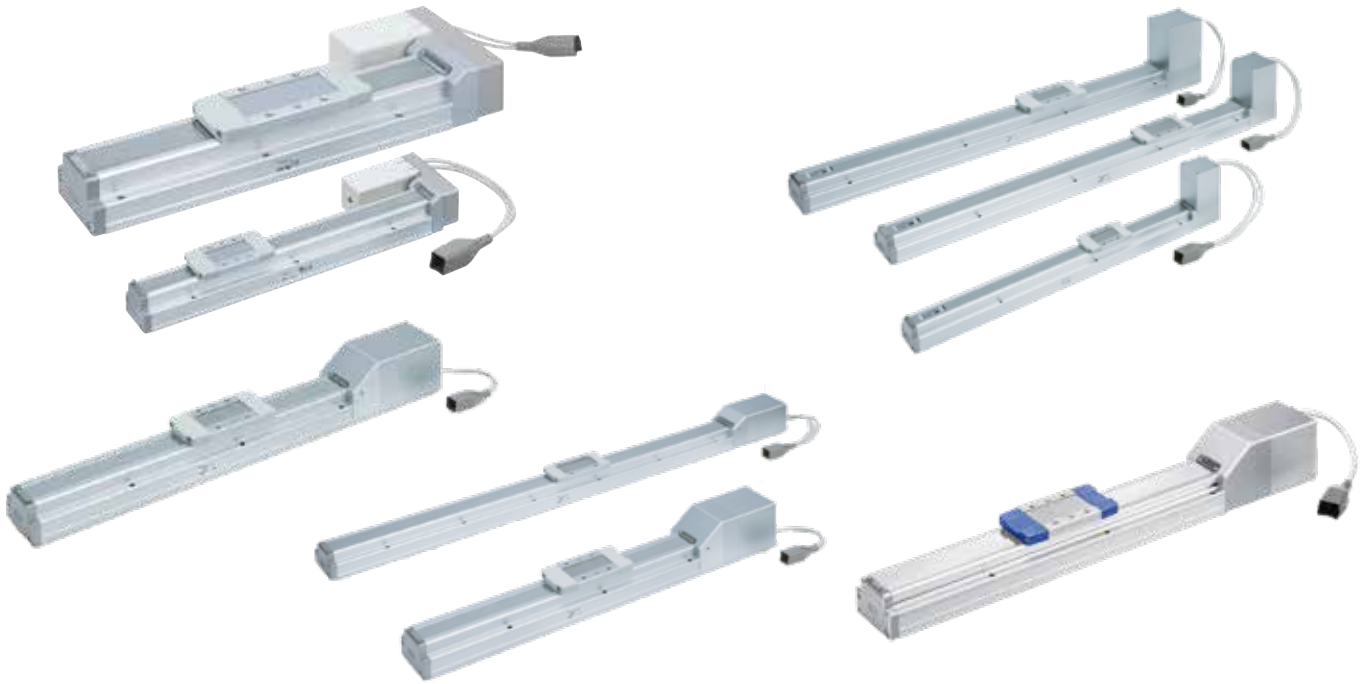

## Anwendungsbeispiele

Pick-and-Place-Anwendungen

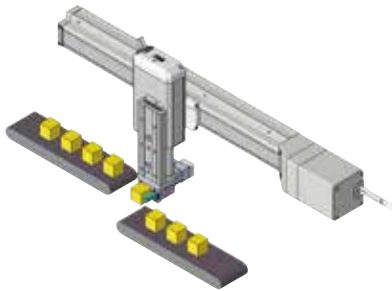

vertikale Anwendung

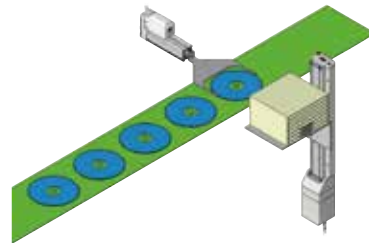

Präzise Positionierung der Werkstücke

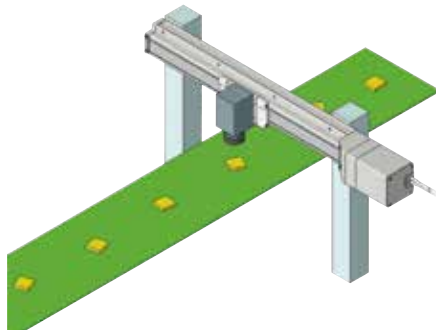

Lade- und Entladetransfer von Werkstücken

