

Traffa

Bedienhandbuch
KompaktSchlitten LES

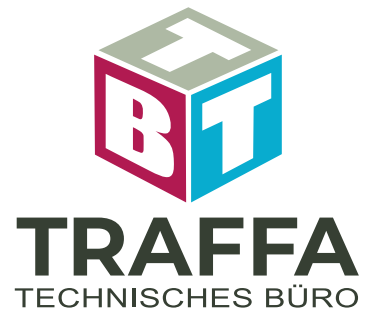

Innovative Antriebslösungen

Der optimale Antrieb individuell für Ihre Anforderung



Operation Manual

PRODUCT NAME

Electric Slide Table

MODEL / Series / Product Number

LES Series

Applicable models: LES[R], LES[L], LES[D], LESH[R], LESH[L], LESH[D]

R Type

- Standard
- /LES[R] Series



L Type

- Standard
- /LES[L] Series



D Type

- Standard
- /LES[D] Series



<Controller>
LEC Series

This manual describes the actuators operation in combination with the LEC*6 series controllers.
Refer to the manual relevant to the controller being used for full operating instructions.

SMC Corporation

Safety Instructions	2
1. Procedure before operation/simple setting to use straight away4	
1.1 Preparation	4
1.2 Controller setting software version.....	5
1.3 Teaching box	7
2. Electric Slide table /LES Series.....	9
2.1 Specification.....	9
2. 2 How to Order	13
2.3 Construction.....	14
3. Product Outline	18
3.1 System construction	18
3.2 Setting Function.....	19
3.3 Step data setting	22
3.4 Parameter setting.....	33
4. Wiring of cables / Common precautions.....	37
5. Electric actuators / Common precautions	38
5.1 Design and selection	38
5.2 Mounting.....	39
5.3 Handling	40
5.4 Operating environment	41
5.5 Maintenance	41
5.6 Precautions for actuator with lock	42
6. Electric actuators / Common precautions	43
6.1 Design and selection	43
6.2 Handling	43
6.3 Precaution on maintenance	48
6.4 Replacement of belt (LES**R / LES**L)	49
6.5 How to spreading grease	51
7. Troubleshooting	52



LES Series / Electric Slide table Safety Instructions

These safety instructions are intended to prevent hazardous situations and /or equipment damage. These instructions indicate the level of potential hazard with the labels of "Caution," "Warning" or "Danger." They are all important notes for safety and must be followed in addition to International Standards (ISO /IEC), Japan Industrial Standards (JIS)*1) and other safety regulations*2).

*1) ISO 4414: Pneumatic fluid power -- General rules relating to systems

ISO 4413: Hydraulic fluid power -- General rules relating to systems

IEC 60204-1: Safety of machinery -- Electrical equipment of machines (Part 1: General requirements)

ISO 10218-1992: Manipulating industrial robots -- Safety

JIS B 8370: General rules for pneumatic equipment.

JIS B 8361: General rules for hydraulic equipment.

JIS B 9960-1: Safety of machinery -- Electrical equipment for machines. (Part 1: General requirements)

JIS B 8433-1993: Manipulating industrial robots - Safety. etc.

*2) Labor Safety and Sanitation Law, etc.



Caution

Caution indicates a hazard with a low level of risk which, if not avoided, could result in minor or moderate injury.



Warning

Warning indicates a hazard with a medium level of risk which, if not avoided, could result in death or serious injury.



Danger

Danger indicates a hazard with a high level of risk which, if not avoided, will result in death or serious injury.

Warning

1. The compatibility of the product is the responsibility of the person who designs the equipment or decides its specifications.

Since the product specified here is used under various operating conditions, its compatibility with specific equipment must be decided by the person who designs the equipment or decides its specifications based on necessary analysis and test results.

The expected performance and safety assurance of the equipment will be the responsibility of the person who has determined its compatibility with the product.

This person should also continuously review all specifications of the product referring to its latest catalog information, with a view to giving due consideration to any possibility of equipment failure when configuring the equipment.

2. Only personnel with appropriate training should operate machinery and equipment.

The product specified here may become unsafe if handled incorrectly.

The assembly, operation and maintenance of machines or equipment including our products must be performed by an operator who is appropriately trained and experienced.

3. Do not service or attempt to remove product and machinery /equipment until safety is confirmed.

The inspection and maintenance of machinery /equipment should only be performed after measures to prevent falling or runaway of the driven objects have been confirmed.

When the product is to be removed, confirm that the safety measures as mentioned above are implemented and the power from any appropriate source is cut, and read and understand the specific product precautions of all relevant products carefully.

Before machinery /equipment is restarted, take measures to prevent unexpected operation and malfunction.

4. Contact SMC beforehand and take special consideration of safety measures if the product is to be used in any of the following conditions.

1) Conditions and environments outside of the given specifications, or use outdoors or in a place exposed to direct sunlight.

2) Installation on equipment in conjunction with atomic energy, railways, air navigation, space, shipping, vehicles, military, medical treatment, combustion and recreation, or equipment in contact with food and beverages, emergency stop circuits, clutch and brake circuits in press applications, safety equipment or other applications unsuitable for the standard specifications described in the product catalog.

3) An application which could have negative effects on people, property, or animals requiring special safety analysis.

4) Use in an interlock circuit, which requires the provision of double interlock for possible failure by using a mechanical protective function, and periodical checks to confirm proper operation.



LES Series / Electric Slide table Safety Instructions

Caution

The product is provided for use in manufacturing industries.

The product herein described is basically provided for peaceful use in manufacturing industries. If considering using the product in other industries, consult SMC beforehand and exchange specifications or a contract if necessary.
If anything is unclear, contact your nearest sales branch.

Limited warranty and Disclaimer /Compliance Requirements

The product used is subject to the following “Limited warranty and Disclaimer” and “Compliance Requirements”.

Read and accept them before using the product.

Limited warranty and Disclaimer

The warranty period of the product is 1 year in service or 1.5 years after the product is delivered.*3) Also, the product may have specified durability, running distance or replacement parts. Please consult your nearest sales branch.

For any failure or damage reported within the warranty period which is clearly our responsibility, a replacement product or necessary parts will be provided.

This limited warranty applies only to our product independently, and not to any other damage incurred due to the failure of the product.

Prior to using SMC products, please read and understand the warranty terms and disclaimers noted in the specified catalog for the particular products.

***3) Vacuum pads are excluded from this 1 year warranty.**

A vacuum pad is a consumable part, so it is warranted for a year after it is delivered.

Also, even within the warranty period, the wear of a product due to the use of the vacuum pad or failure due to the deterioration of rubber material are not covered by the limited warranty.

Compliance Requirements

When the product is exported, strictly follow the laws required by the Ministry of Economy, Trade and Industry (Foreign Exchange and Foreign Trade Control Law).

1. Procedure before operation/simple setting to use straight away

The controller is already set with the data of the actuator.

With the simple setting “easy mode”, it can be operated and running parameters can be changed easily.

1.1 Preparation

(1) Items to be prepared

Please check the label, and the quantity of accessories, to confirm that it is the product that was ordered.

Table 1. Components

No.	Part name	Qty
(1)	Electric slide table	1
(2)	Controller	1
(3)	Power supply plug	1
(4)	Actuator cable	1
(5)	I/O cable (Not use in this section)	1
(6)	Teaching box	1
(7)	Controller setting kit [The controller setting software, The communication cable, USB cable and conversion unit are included.]	1

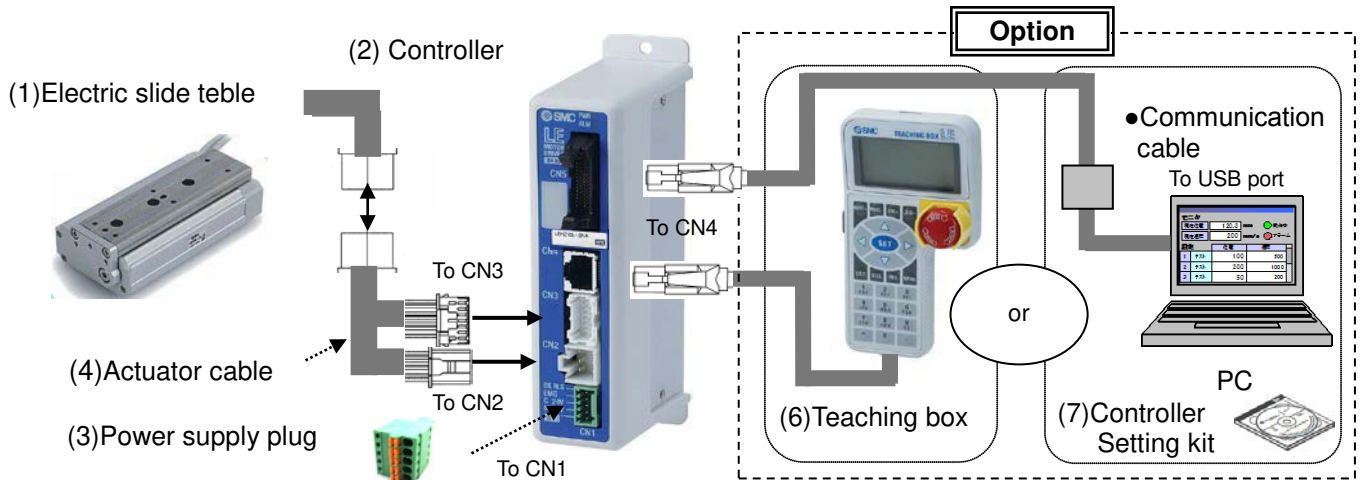

Table 2. Items to be prepared by the customer

Part name	Conditions
Power supply 24VDC Do not use the power supply with “Inrush-restraining type”	Refer to power consumption of each actuator / See 2.1 Specification on p.9-12 (Prepare the power supply that has capacity of “Moment max.power consumption” or more.)
Wire AWG20 (0.5mm ²)	Stripped wire length 8mm
Power supply plug Wiring	<p>Connect the plus side of 24VDC to the C24V, M24V and EMG terminals of the power supply plug, and the minus side to the 0V terminal. When conformity to UL is required, the electric actuator and controller should be used with a UL1310 Class 2 power supply.</p> <p><u>Step motor (servo 24VDC)</u></p> <p>Push the open/close lever and insert the wire into the electrical wire entry</p> <p><u>Servo motor (24VDC)</u></p>

1.2 Controller setting software version

1. Installation of software

With the controller setting software CD-ROM, install the communication unit software, following the "Software Installation procedure" (PDF)

2. Startup of software

After turning on the controller power supply, start up the ACT Controller setting software.

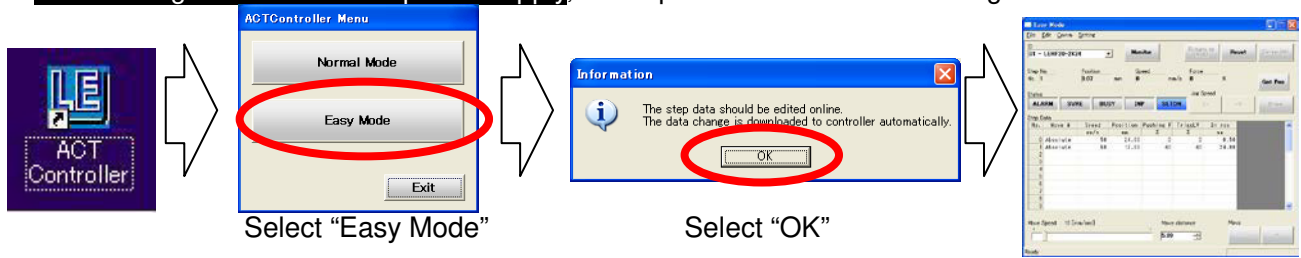

3. JOG Drive

a. Driving preparation: Servo On → Return to ORIG

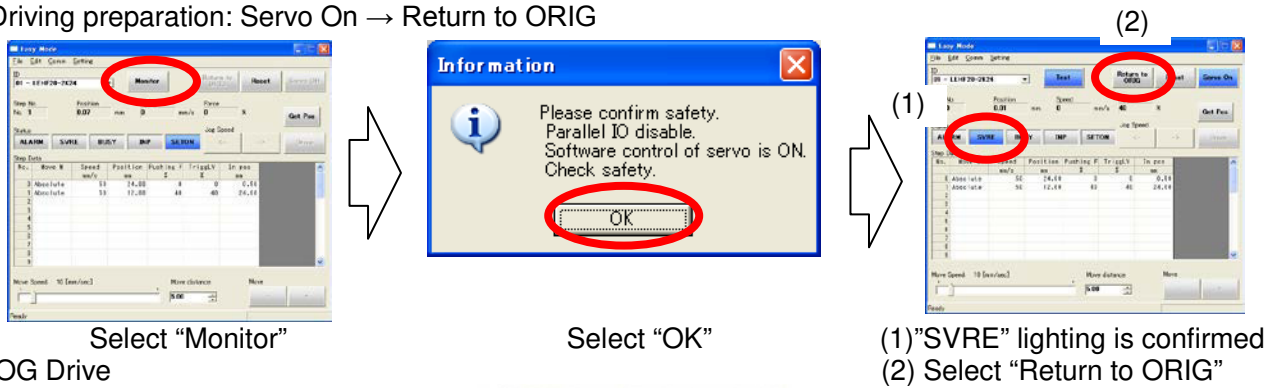

b. JOG Drive

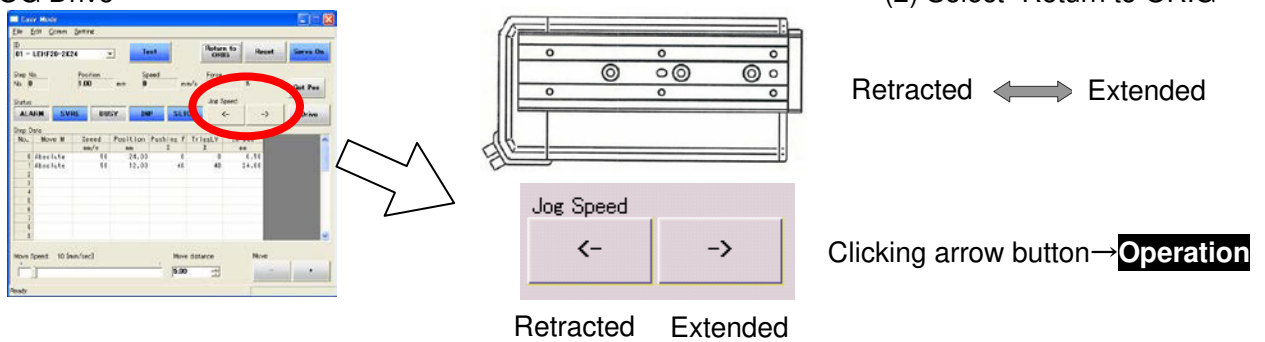

c. Driving stop: Servo Off

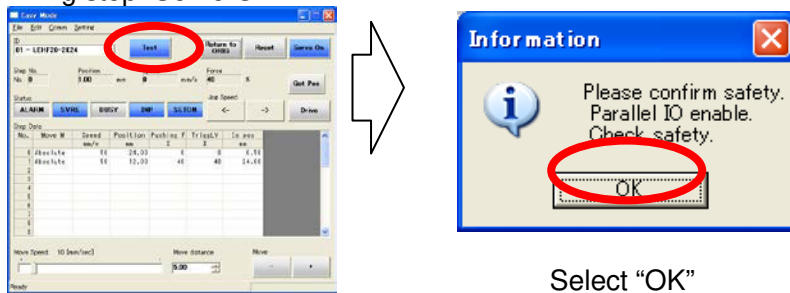

⚠ Caution

If an alarm is generated

(1) When "ALARM" is generated, release it by selecting (2) Reset.

In the case of an alarm code that cannot be released with "Reset", turn the power supply OFF and ON again.

Note) For details of alarm codes, refer to the Controller Operation Manual.



4. TEST Drive / Step No.0 → No.1 → No.0...

a. Driving preparation: Servo On → Return to ORIG / Refer to “3.JOG Drive”.

b. TEST Drive

“Step No.0” Operation

Procedure 1:
Select “Step No.0”
You can select anywhere in the row

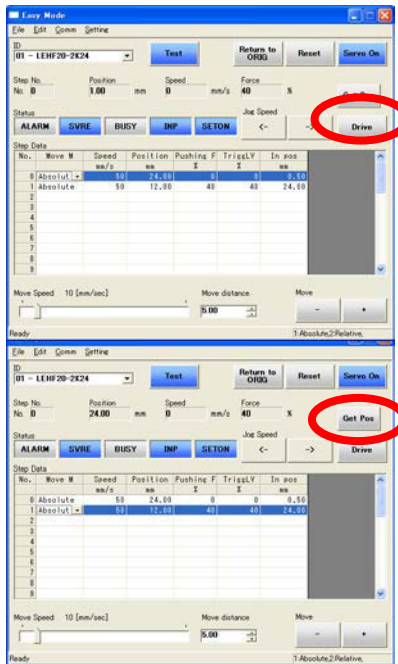

Procedure 2:
Select “Drive”

→ **Operation**

“Step No.1” Operation

Procedure 3:
Select “Step No.1”
You can select anywhere in the row



Procedure 4:
Select “Drive”

→ **Operation**

c. Driving stop : Servo Off / Refer to “3.JOG Drive”.

5. Step data change

Ex) “Step No.0” / Positioning operation / At the time of shipment, Step No.0 is set to positioning operation

Step Data						
No.	Move M	Speed	Position	Pushing F	TriggLV	In pos
		mm/s	mm	%	%	mm
0	Absolute	400	50.00	0	0	1.00

Change of positioning stop position

Position: 50mm → 20mm

Input “20”

Step Data						
No.	Move M	Speed	Position	Pushing F	TriggLV	In pos
		mm/s	mm	%	%	mm
0	Absolute	400	20.00	0	0	1.00

For details of operation, and relationship between operation procedure and input/output signals, refer to “3.3 Step Data” setting method p. 22 to 32.

6. Controller setting software screen explanation

Refer to the “Help / Easy mode” menu in the “ACT Controller” setting software.

1.3 Teaching box

1. Name

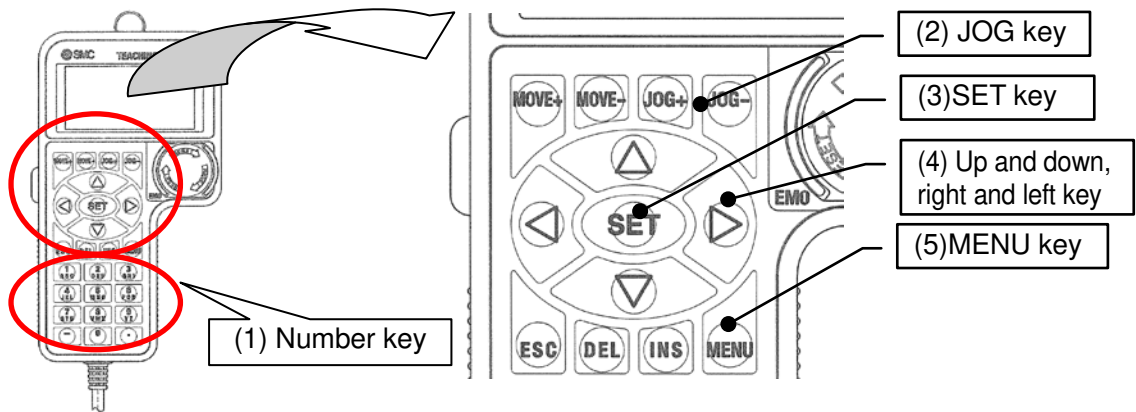

2. JOG Drive

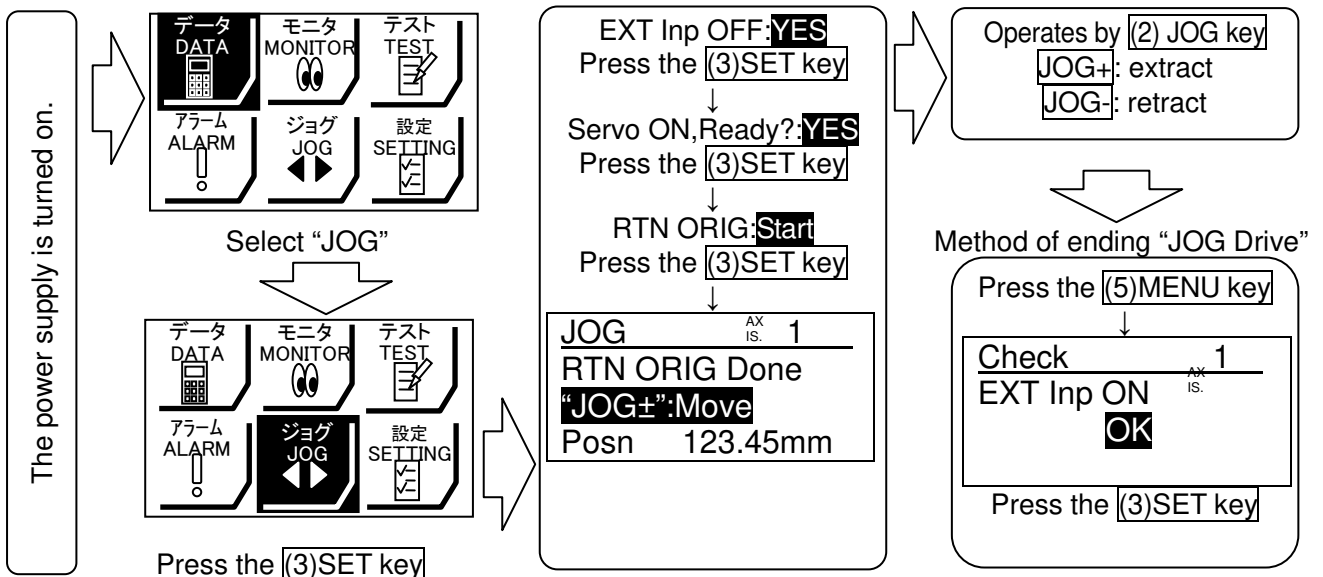

3. TEST Drive / Step No.0 → No.1 → No.0...

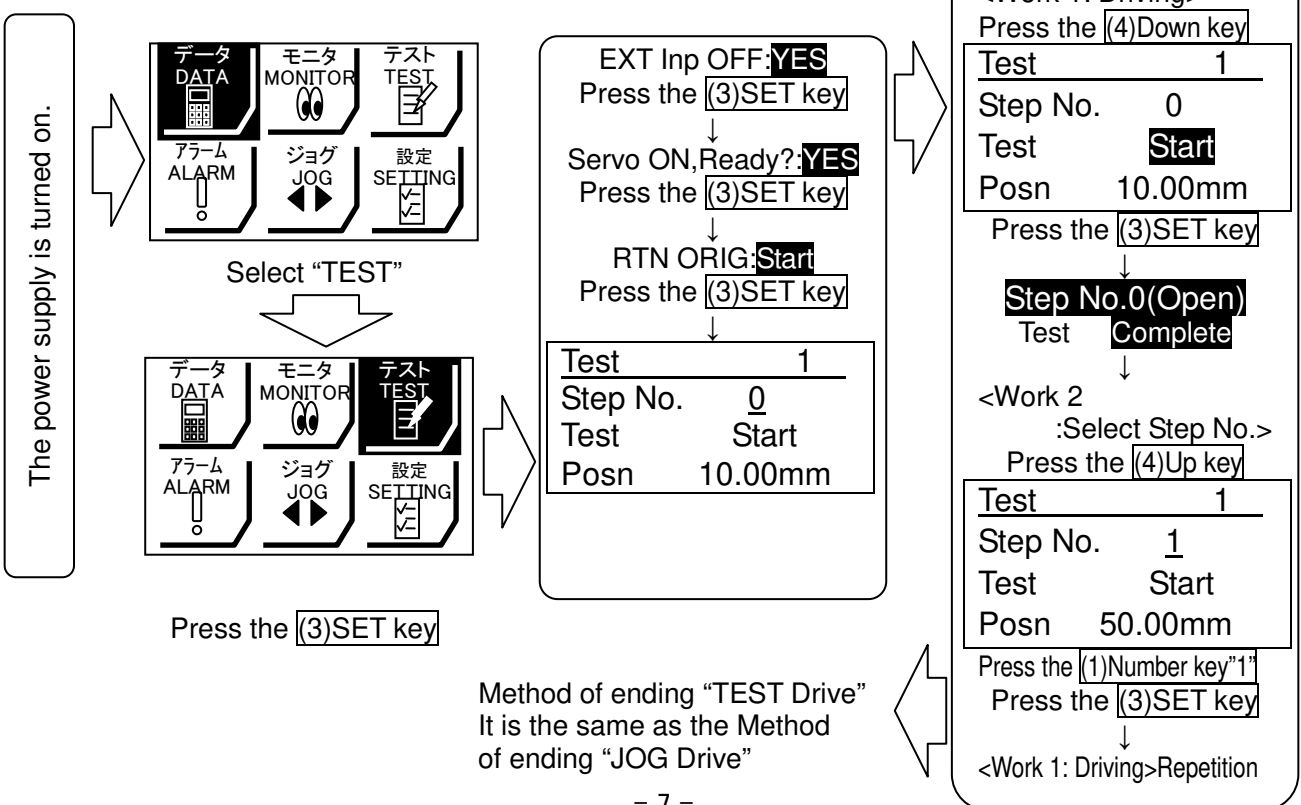

4. Step data change

“Step No.0” / Positioning operation

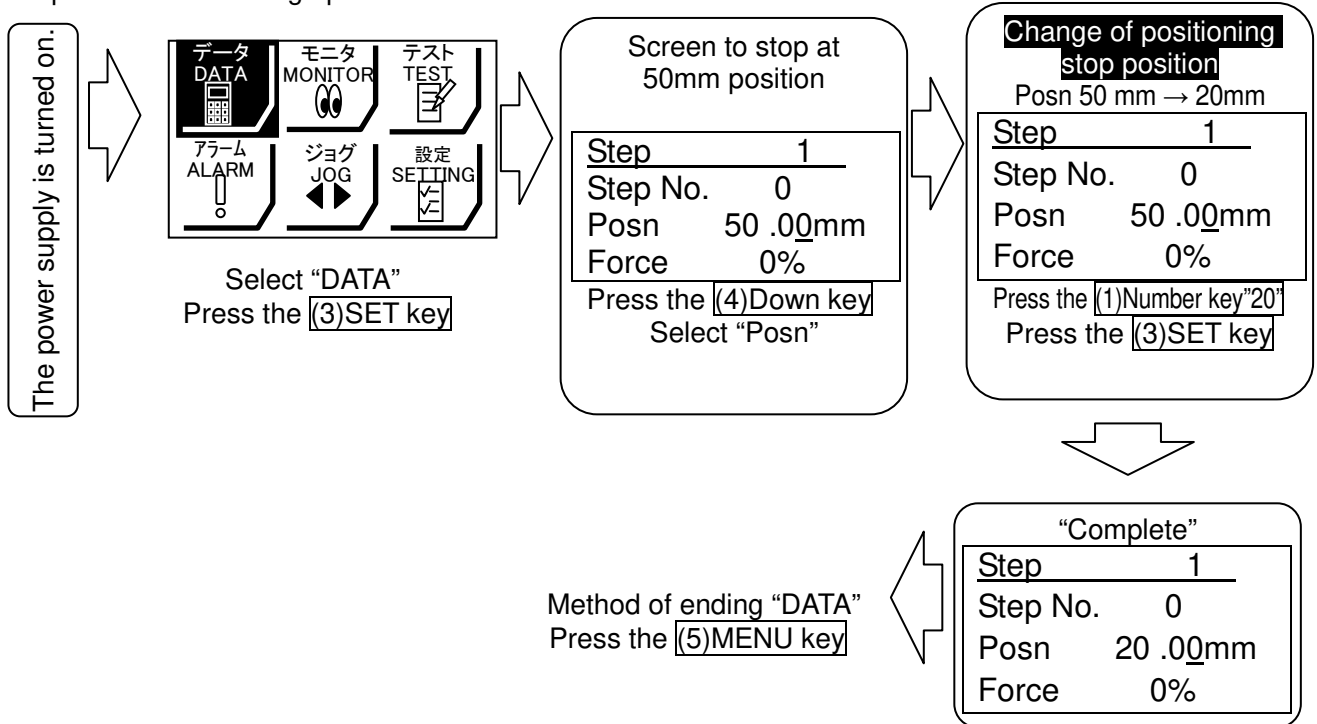

For details of operation, and relationship between operation procedure and input/output signals, refer to “3.3 Step Data” setting method p. 22 to 32.

5. Teaching box detailed explanation

Please refer to the teaching box manual.

2. Electric Slide table /LES Series

2.1 Specification

LES / Step Motor (Servo 24VDC)

Size		LES8□		LES16□		LES25□	
Stroke [mm]		30 , 50 , 75		30 , 50 , 75 , 100		30 , 50 , 75 , 100 , 125 , 150	
Work load [kg] ^{Note1)3)}	Horizontal	1		3		5	
	Vertical	0.5	0.25	3	1.5	5	2.5
Pushing force [N] 30to70% ^{Note2)3)}		6 to 15	4 to 10	23.5 to 55	15 to 35	77 to 180	43 to 100
Speed [mm/s] ^{Note1)3)}		10 to 200	20 to 400	10 to 200	20 to 400	10 to 200	20 to 400
Pushing speed [mm/s]		10 to 20	20	10 to 20	20	10 to 20	20
Acceleration/Deceleration [mm/s ²]		5,000 or less					
Positioning repeatability [mm]		±0.05					
Lost motion [mm] ^{Note4)}		0.3 or less					
Screw lead [mm]		4	8	5	10	8	16
Impact / vibration resistance [m/sec ²] ^{Note5)}		50 / 20					
Actuation type		Slide screw + belt (R/L type) , Slide screw (D type)					
Guide type		Linear guide (circulating type)					
Operating temp. range [°C]		5 to 40					
Operating humidity range [%RH]		90 or less (No condensation)					
Static Allowable Moment [Nm]	Pitching	2		4.8		14.1	
	Yawing	2		4.8		14.1	
	Rolling	0.8		1.8		4.8	
Weight [kg]	Without lock RL type / D type	30st : 0.45/0.40		30st : 0.91/0.77		30st : 1.81/1.82	
		50st : 0.54/0.52		50st : 1.00/0.90		50st : 2.07/2.05	
		75st : 0.59/0.58		75st : 1.16/1.11		75st : 2.41/2.35	
				100st : 1.24/1.20		100st : 3.21/3.07	
						125st : 3.44/3.27	
						150st : 3.68/3.47	
	With lock RL type / D type	30st : -/0.47		30st : -/0.90		30st : -/2.08	
		50st : -/0.59		50st : -/1.03		50st : 2.34/2.31	
				75st : 1.29/1.25		75st : 2.68/2.61	
				100st : 1.37/1.33		100st : 3.48/3.33	
						125st : 3.71/3.53	
						150st : 3.95/3.74	
Motor size [mm]		20		28		42	
Motor type		HB type 2-phase step motor (Unipolar connection)					
Encoder		Incremental A/B phase (800 pulse/rotation)					
Rated voltage [VDC]		24+/-10%					
Power consumption [W] ^{Note6)}		18		69		45	
Standby power consumption when operating [W] ^{Note7)}		7		15		13	
Moment max. power consumption[W] ^{Note8)}		35		69		67	
Lock unit specification	Type	No excitation operating type					
	Holding force [N]	24	2.5	300	48	500	77
	Power consumption [W] ^{Note10)}	3.5		2.9		5	
	Rated voltage [VDC]	24+/-10%					

Note 1) The speed is dependent on the workload. Check the "Speed-workload graphs" for the selected model in the catalogue or the operation manual.

Note 2) The accuracy of the pushing force is ±20% of the max. pushing force.
The max. setting for the pushing force is 70% of the max. pushing force.

Note 3) The speed and force may change depending on the cable length, load and mounting conditions.
Furthermore, if the cable length exceeds 5m then it will decrease by up to 10% for each 5m. (At 15m : Reduced by up to 20%)

Note 4) A reference value for correcting an error in reciprocal operation.

Note 5) Impact resistance:

No malfunction occurred when the actuator was tested with a drop tester in both an axial direction and a perpendicular direction to the lead screw. (The test was performed with the actuator in the initial state)

Vibration resistance:

No malfunction occurred in a test ranging between 45 to 2000 Hz when the actuator was tested in both an axial direction and a perpendicular direction to the lead screw. (The test was performed with the actuator in the initial state)

Note 6) The "Power consumption" (including the controller) is for when the actuator is operating.

Note 7) The "Standby power consumption when operating" (including the controller) is for when the actuator is stopped in the set position with no applied force in the direction of the actuator movement.

Note 8) The "Momentary max. power consumption" (including the controller) is for when the actuator is operating.
This value can be used for the selection of the power supply.

Note 9) Only applies to actuators supplied with a lock.

Note 10) For the actuator with lock, please add the power consumption for the lock.

LES / Servo Motor(24VDC)

Size		LES8□A		LES16□A		LESH25 ^R _L A		
Actuator specification	Stroke [mm]	30, 50, 75		30, 50, 75, 100		30, 50, 75, 100, 125, 150		
	Work load [kg]	Horizontal	1		3		5	
		Vertical	1	0.5	3	1.5	4	2
	Pushing force [N] 50to100% (LESH8□A:50 to 75%) ^{Note2)}	7.5 to 11	5 to 7.5	17.5 to 35	10 to 20	31 to 62	19 to 38	
	Speed [mm/s]	1 to 200	1 to 400	1 to 200	1 to 400	1 to 200	1 to 400	
	Pushing speed [mm/s]	1 to 20						
	Acceleration/Deceleration [mm/s ²]	5,000 or less						
	Positioning repeatability [mm]	±0.05						
	Lost motion [mm] ^{Note3)}	0.3 or less						
	Screw lead [mm]	4	8	5	10	8	16	
	Impact / vibration resistance [m/sec ²] ^{Note4)}	50 / 20						
	Actuation type	Slide screw + belt (R/L type), Slide screw (D type)						
	Guide type	Linear guide (circulating type)						
	Operating temp. range [°C]	5 to 40						
	Operating humidity range [%RH]	90 or less (No condensation)						
	Static Allowable Moment [Nm]	Pitching	2		4.8		14.1	
		Yawing	2		4.8		14.1	
		Rolling	0.8		1.8		4.8	
	Weight [kg]	Without lock RL type / D type	30st : 0.45/0.40		30st : 0.91/0.77		30st : 1.81/-	
			50st : 0.54/0.52		50st : 1.00/0.90		50st : 2.07/-	
75st : 0.59/0.58				75st : 1.16/1.11		75st : 2.41/-		
With lock RL type / D type		30st : -/0.47		30st : -/0.90		30st : -/-		
		50st : -/0.59		50st : -/1.03		50st : 2.34/-		
		75st : 0.66/0.65		75st : 1.29/1.25		75st : 2.68/-		
Electric specification	Motor size [mm]	20		28		42		
	Motor output [W]	10		30		36		
	Motor type	Servo motor (Servo 24VDC)						
	Encoder	Incremental A/B phase (800 pulse/rotation) / Z phase						
	Rated voltage [VDC]	24±10%						
	Power consumption [W] ^{Note5)}	42		68		97		
	Standby power consumption when operating [W] ^{Note6)}	Horizontal : 8		Horizontal : 9		Horizontal : 16		
		Vertical : 19		Vertical : 23		Vertical : 32		
	Moment max. power consumption [W] ^{Note7)}	71		102		111		
	Lock unit specification	Type	No excitation operating type					
Holding force [N]		24	2.5	300	48	500	77	
Power consumption [W] ^{Note9)}		3.5		2.9		5		
Rated voltage [VDC]		24±10%						

Note 1) LES25DA is not available.

Note 2) The accuracy of the pushing force is ±20% of the max. pushing force.

The setting for the pushing force is 50-75% of LESH8□A pushing force.

Note 3) A reference value for correcting an error in reciprocal operation.

Note 4) Impact resistance: No malfunction occurred when the actuator was tested with a drop tester in both an axial direction and a perpendicular direction to the lead screw.

(The test was performed with the actuator in the initial state)

Vibration resistance: No malfunction occurred in a test ranging between 45 to 2000 Hz. Test was performed in both an axial direction and a perpendicular direction to the lead screw.

(The test was performed with the slide table in the initial state.)

Note 5) The "Power consumption" (including the controller) is for when the actuator is operating.

Note 6) The "Standby power consumption when operating" (including the controller) is for when the actuator is stopped in the set position with no applied force in the direction of the actuator movement.

Note 7) The "Momentary max. power consumption" (including the controller) is for when the actuator is operating. This value can be used for the selection of the power supply.

Note 8) Only applies to actuators supplied with a lock.

Note 9) For the actuator with lock, please add the power consumption for the lock.

LESH / Step Motor (Servo 24VDC)

Size		LESH8□		LESH16□		LESH25□			
Actuator specification	Stroke [mm]	50 , 75		50 , 100		50 , 100 , 150			
	Work load [kg] ^{Note1)3)}	Horizontal	2	1	8	5	12	8	
		Vertical	0.5	0.25	2	1	4	2	
	Pushing force [N] 30to70% ^{Note2)3)}	6 to 15		4 to 10		23.5 to 55 15 to 35		77 to 180 43 to 100	
	Speed [mm/s] ^{Note1)3)}	10 to 200		20 to 400		10 to 200 20 to 400		10 to 150 20 to 400	
	Pushing speed [mm/s]	10 to 20		20		10 to 20 20		10 to 20 20	
	Acceleration/Deceleration [mm/s ²]	5,000 or less							
	Positioning repeatability [mm]	+/-0.05							
	Lost motion [mm] ^{Note4)}	0.15 or less							
	Screw lead [mm]	4	8	5	10	8	16		
	Impact / vibration resistance [m/sec ²] ^{Note5)}	50 / 20							
	Actuation type	Slide screw + belt (R/L type) , Slide screw (D type)							
	Guide type	Linear guide (circulating type)							
	Operating temp. range [°C]	5 to 40							
	Operating humidity range [%RH]	90 or less (No condensation)							
Static Allowable Moment [Nm]	Pitching	11		50st:26 / 100st:43		50st: 77/100st:112/150st:154			
	Yawing	11		50st:26 / 100st:43		50st: 77/100st:112/150st:154			
	Rolling	12		49		50st:146/100st:177/150st:152			
Weight [kg]	Without lock RL type / D type	50st : 0.55/0.57		50st : 1.15/1.25		50st : 2.50/2.52			
		75st : 0.70/0.70		100st : 1.60/1.70		100st : 3.30/3.27			
	With lock RL type / D type	50st : -/0.66		50st : -/1.36		50st : 2.84/2.86			
		75st : 0.79/0.79		100st : 1.71/1.81		100st : 3.64/3.61			
						150st : 4.60/3.94			
Electric specification	Motor size [mm]	20		28		42			
	Motor type	HB type 2-phase step motor (Unipolar connection)							
	Encoder	Incremental A/B phase (800 pulse/rotation)							
	Rated voltage [VDC]	24+/-10%							
	Power consumption [W] ^{Note6)}	20		43		67			
	Standby power consumption when operating [W] ^{Note7)}	7		15		13			
	Moment max. power consumption[W] ^{Note8)}	35		60		74			
Lock unit specification	Type	No excitation operating type							
	Holding force [N]	24	2.5	300	48	500	77		
	Power consumption [W] ^{Note10)}	3.5		2.9		5			
	Rated voltage [VDC]	24+/-10%							

Note 1) The speed is dependent on the workload. Check the "Speed-workload graphs" for the selected model in the catalogue or the operation manual.

Note 2) The accuracy of the pushing force is ±20% of the max. pushing force.

The max. setting for the pushing force is 70% of the max. pushing force.

Note 3) The speed and force may change depending on the cable length, load and mounting conditions.

Furthermore, if the cable length exceeds 5m then it will decrease by up to 10% for each 5m.(At 15m : Reduced by up to 20%)

Note 4) A reference value for correcting an error in reciprocal operation.

Note 5) Impact resistance:

No malfunction occurred when the actuator was tested with a drop tester in both an axial direction and a perpendicular direction to the lead screw. (The test was performed with the actuator in the initial state)

Vibration resistance:

No malfunction occurred in a test ranging between 45 to 2000 Hz when the actuator was tested in both an axial direction and a perpendicular direction to the lead screw. (The test was performed with the actuator in the initial state)

Note 6) The "Power consumption" (including the controller) is for when the actuator is operating.

Note 7) The "Standby power consumption when operating" (including the controller) is for when the actuator is stopped in the set position with no applied force in the direction of the actuator movement.

Note 8) The "Momentary max. power consumption" (including the controller) is for when the actuator is operating.

This value can be used for the selection of the power supply.

Note 9) Only applies to actuators supplied with a lock.

Note10) For the actuator with lock, please add the power consumption for the lock.

LESH / Servo Motor(24VDC)

Size		LESH8□A		LESH16□A		LESH25 ^R _L A		
Actuator specification	Stroke [mm]	50, 75		50, 100		50, 100, 150		
	Work load [kg]	Horizontal	2	1	5	2.5	6	4
		Vertical	0.5	0.25	2	1	2.5	1.5
	Pushing force [N] 50to100% (LESH8□A:50 to 75%) ^{Note2)}		7.5 to 11	5 to 7.5	17.5 to 35	10 to 20	31 to 62	19 to 38
	Speed [mm/s]		1 to 200	1 to 400	1 to 200	1 to 400	1 to 150	1 to 400
	Pushing speed [mm/s]		1 to 20					
	Acceleration/Deceleration [mm/s ²]		5,000 or less					
	Positioning repeatability [mm]		+/-0.05					
	Lost motion [mm] ^{Note3)}		0.15 or less					
	Screw lead [mm]		4	8	5	10	8	16
	Impact / vibration resistance [m/sec ²] ^{Note4)}		50 / 20					
	Actuation type		Slide screw + belt (R/L type) , Slide screw (D type)					
	Guide type		Linear guide (circulating type)					
	Operating temp. range [°C]		5 to 40					
	Operating humidity range [%RH]		90 or less (No condensation)					
	Static Allowable Moment [Nm]	Pitching	11		50st:26 / 100st:43		50st: 77/100st:112/150st:154	
Yawing		11		50st:26 / 100st:43		50st: 77/100st:112/150st:154		
Rolling		12		49		50st:146/100st:177/150st:152		
Weight [kg]	Without lock RL type / D type	50st : 0.55/0.57		50st : 1.15/1.25		50st : 2.50/-		
		75st : 0.70/0.70		100st : 1.60/1.70		100st : 3.30/-		
	With lock RL type / D type	50st : -/0.66		50st : -/1.36		50st : 2.84/-		
		75st : 0.79/0.79		100st : 1.71/1.81		100st : 3.64/-		
						150st : 4.60/-		
Electric specification	Motor size [mm]	20		28		42		
	Motor output [W]	10		30		36		
	Motor type	Servo motor (Servo 24VDC)						
	Encoder	Incremental A/B phase (800 pulse/rotation) / Z phase						
	Rated voltage [VDC]	24+/-10%						
	Power consumption [W] ^{Note5)}	58		84		144		
	Standby power consumption when operating [W] ^{Note6)}	Horizontal : 4 Vertical : 7		Horizontal : 2 Vertical : 15		Horizontal : 4 Vertical : 43		
	Moment max. power consumption [W] ^{Note7)}	84		124		158		
Lock unit specification	Type	No excitation operating type						
	Holding force [N]	24	2.5	300	48	500	77	
	Power consumption [W] ^{Note9)}	3.5		2.9		5		
	Rated voltage [VDC]	24+/-10%						

Note 1) LESH25DA is not available.

Note 2) The accuracy of the pushing force is ±20% of the max. pushing force.

The setting for the pushing force is 50-75% of LESH8□A pushing force.

Note 3) A reference value for correcting an error in reciprocal operation.

Note 4) Impact resistance: No malfunction occurred when the actuator was tested with a drop tester in both an axial direction and a perpendicular direction to the lead screw.

(The test was performed with the actuator in the initial state)

Vibration resistance: No malfunction occurred in a test ranging between 45 to 2000 Hz. Test was performed in both an axial direction and a perpendicular direction to the lead screw.

(The test was performed with the slide table in the initial state.)

Note 5) The "Power consumption" (including the controller) is for when the actuator is operating.

Note 6) The "Standby power consumption when operating" (including the controller) is for when the actuator is stopped in the set position with no applied force in the direction of the actuator movement.

Note 7) The "Momentary max. power consumption" (including the controller) is for when the actuator is operating. This value can be used for the selection of the power supply.

Note 8) Only applies to actuators supplied with a lock.

Note 9) For the actuator with lock, please add the power consumption for the lock.

2. 2 How to Order

L E S H 16 R [] J - 50 [] [] [] - R 1 6N 1 []

Table type

Nil	Low-profile type
H	High rigidity type

Size

8
16
25

Type

R	R Type
L	L Type
D	D Type

Motor type

Nil	Step motor (Servo DC24V)	LECP6 LECP1 LECPMJ LECPA JXC9
A	Servo motor* (DC24V)	LECA6

*LES□25DA cannot correspond.

Screw read (mm)

Nil	LES□8	LES□16	LES□25
J	8	10	16
K	4	5	8

Stroke (mm)

	30	50	75	100	125	150
LES8	○	○	●	●		
LES16	○	○	●	●		
LES25	○	●	●	●	●	●
LESH8	○	○	●			
LESH16		○		●		
LESH25		●		●		●

*Only "R/L type with ○" can not be selected "With lock".

Motor option

Nil	Without lock
B	With lock

Body option

Nil	Basic type
S	Dust proof specification

Mounting style
(*Only "D type" can be selected.)

Nil	Without side holder
H	With side holder (4pcs)

Actuator cable type

Nil	Without cable
R	With robotic type cable
S	Standard cable*

*Only "Step motor" can be selected.

Actuator cable length (m)

Nil	Without cable	8	8*
1	1.5	A	10*
3	3	B	15*
5	5	C	20*

*Produced upon receipt of order.
(Only "Robotic type cable" can be selected.)

Controller / Driver type

Nil	Without controller / driver type	
6N	LECP6/LECA6 (Step data input type)	NPN
6P		PNP
1N	LECP1* (Programless type)	NPN
1P		PNP
MJ	LECPMJ* (CC-Link Direct input type)	-
AN	LECPA* (Pulse input type)	NPN
AP		PNP
CP	JXC9* (EtherNet/IP Direct input type)	-

*Only available for the motor type "Step motor"

Controller / Driver option

- Controller / Driver type : 6*, 1*, A*, MJ

Nil	Screw mounting style
D	DIN rail mounting style*

- Controller / Driver type : C9

7	Screw mounting style
8	DIN rail mounting style*

*DIN rail is not included. Order it separately.

I/O cable length, Communication plug connector, Number of axis and type of power supply

- Controller / Driver type : 6*1*A*
I/O cable length (m)*1

Nil	Without cable
1	1.5
3	3 ²
5	5 ²

*1 When "Without controller/driver" is selected for controller/driver types, I/O cable cannot be selected.

*2 When "Pulse input type" is selected for controller. Driver types, pulse input usable only with differential. Only 1.5m cables usable with collector.

- Controller / Driver type : MJ
Communication plug connector

Nil	None
S	Straight type
T	T branch type

- Controller / Driver type:C9
Number of axis and type of power supply

1	1 axis, DC24V
---	---------------

⚠ Caution

The actuator body and controller are sold as a package.

If when only the actuator is purchased separately, confirm that the combination of the controller, which you have and the actuator is compatible. / See 5.3⚠Caution(1) on p.40

<Be sure to check the following before use.>

- Check that actuator label for model number.
This matches the controller.
- Check Parallel I/O configuration matches (NPN or PNP).

(1) **LESH8RJ-50**

NPN

(2)

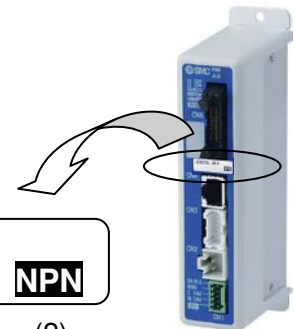

2.3 Construction

•LES*R / LES*L

R type as shown
L type opposite as shown

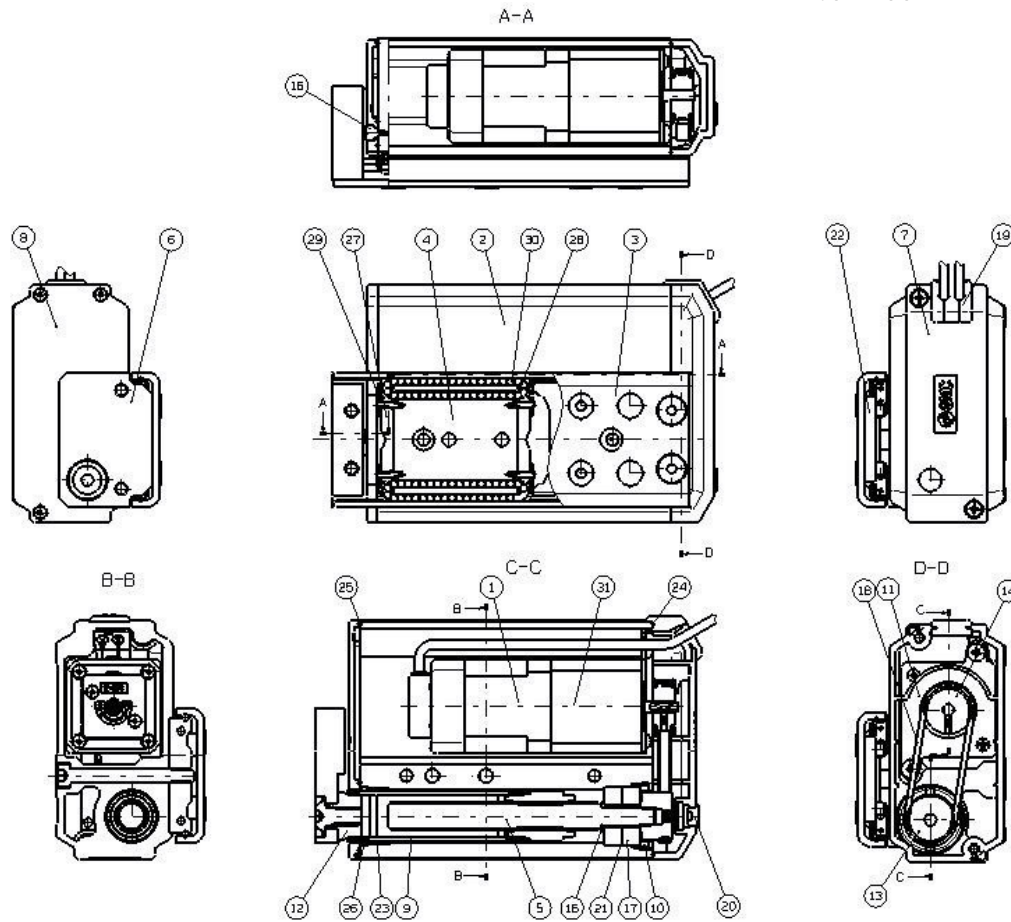

Component parts

No.	Description	Material	Remarks
1	Motor	-	-
2	Body	Aluminum alloy	Hard anodized
3	Table	Stainless steel	Heat treated
4	Guide block	Stainless steel	Heat treated
5	Lead screw	Stainless steel	Special treatment
6	End plate	Aluminum alloy	Hard anodized
7	Pulley cover	Plastic	-
8	End cover	Plastic	-
9	Rod	Stainless steel	-
10	Bearing holder	Carbon steel Copper alloy	Electroless nickel plated Electroless nickel plated(LES25R/L* only)
11	Motor plate	Aluminum alloy	-
12	Socket□	Carbon steel	Electroless nickel plated
13	Lead screw pulley	Aluminum alloy	-
14	Motor pulley	Aluminum alloy	-
15	Spacer	Stainless steel	LES25R/L* only
16	Origin stopper	Carbon steel	Electroless nickel plated
17	Bearing	-	-
18	Belt	-	-
19	Grommet	Plastic	-
20	Cap	Silicone rubber	-
21	Simring□	Steel	-
22	Stopper	Carbon steel	-
23	Bushing	-	Dust proof only
24	Pulley gasket	NBR	Dust proof only
25	End gasket	NBR	Dust proof only
26	Scraper	NBR	Dust proof only
27	Cover	Plastic	-
28	Return guide	Plastic	-
29	Cover Support	Stainless steel	-
30	Steel ball	High carbon chrome bearing steel	-
31	Lock	-	With lock only

Maintenance parts/belt

Size	Part number	備考
LES8□	LE-D-1-1	Without manual override screw
LES16□	LE-D-1-2	—
LES25□	LE-D-1-3	—
LES25□A	LE-D-1-4	—
LES8□	LE-D-1-5	With manual override screw

Maintenance parts/grease

Parts	Order number
Table	GR-S-010(10g)
	GR-S-020(20g)

•LES*D

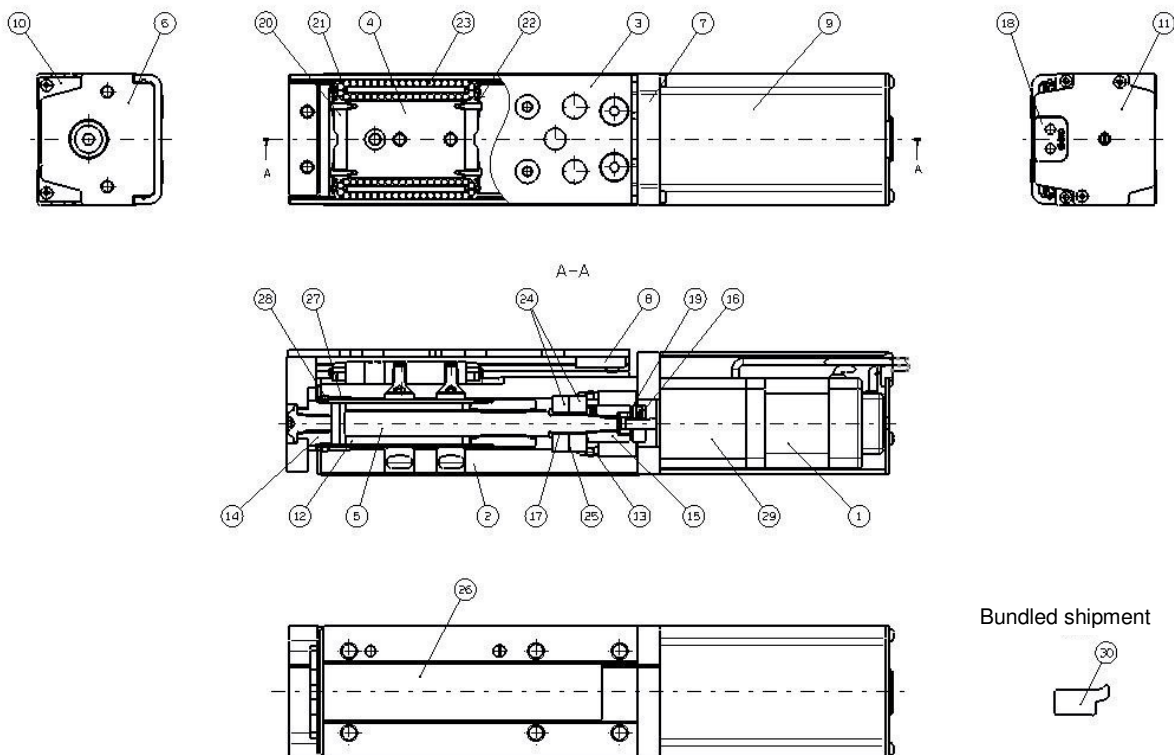

Component parts

No.	Description	Material	Remarks
1	Motor	-	-
2	Body	Aluminum alloy	Hard anodized
3	Table	Stainless steel	Heat treatment + Electroless nickel
4	Guide block	Stainless steel	Heat treatment
5	Lead screw	Stainless steel	Heat treatment + Special plated
6	End plate	Aluminum alloy	Hard anodized
7	Motor flange	Aluminum alloy	Hard anodized
8	Stopper	Carbon steel	-
9	Motor cover	Aluminum alloy	Hard anodized
10	End cover	Aluminum alloy	Hard anodized
11	Motor end cover	Aluminum alloy	Hard anodized
12	Rod	Stainless steel	-
13	Bearing holder	Carbon steel	Electroless nickel plated
		Copper alloy	Electroless nickel plated(LES25D* only)
14	Socket	Carbon steel	Electroless nickel plated
15	Hub(Screw side)	Aluminum alloy	-
16	Hub(Motor side)	Aluminum alloy	-
17	Spacer	Stainless steel	LES25D* only
18	Grommet	NBR	-
19	Spider	NBR	-
20	Cover	Plastic	-
21	Return guide	Plastic	-
22	Cover Support	Stainless steel	-
23	Steel ball	Special steel	-
24	Bearing	-	-
25	Shim ring	Carbon steel	-
26	Masking tape	-	-
27	Bushing	-	Dust proof only
28	Scraper	NBR	Dust proof only / rod part
29	Lock	-	With lock only
30	Side Holder	Aluminum alloy	Hard anodized

Option parts/Side holder

Model	Part number
LES8D	LE-D-3-1
LES16D	LE-D-3-2
LES25D	LE-D-3-3

Maintenance parts/grease

Parts	Order number
Table	GR-S-010(10g)
	GR-S-020(20g)

R type as shown
L type opposite as shown

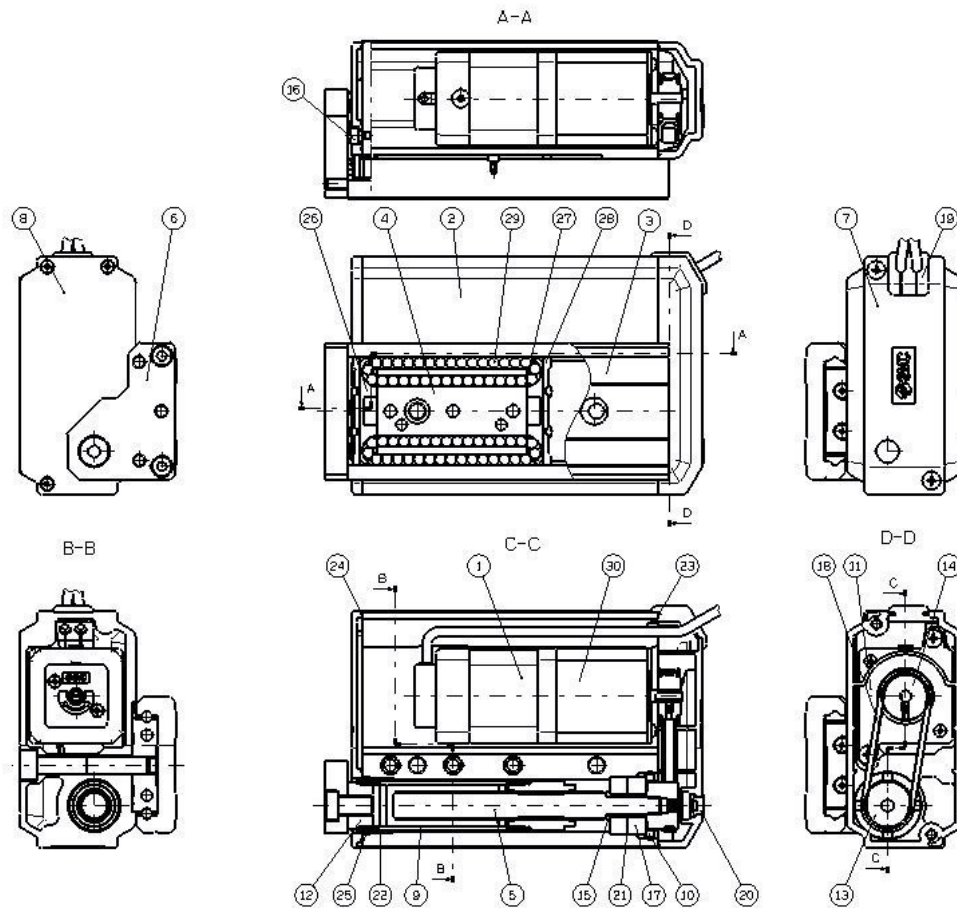

Component parts

No.	Description	Material	Remarks
1	Motor	-	-
2	Body	Aluminum alloy	Hard anodized
3	Table	Stainless steel	Heat treated
4	Guide block	Stainless steel	Heat treated
5	Lead screw	Stainless steel	Special treatment
6	End plate	Aluminum alloy	Hard anodized
7	Pulley cover	Plastic	-
8	End cover	Plastic	-
9	Rod	Stainless steel	-
10	Bearing holder	Carbon steel Copper alloy	Electroless nickel plated Electroless nickel plated(LESH25R/L* only)
11	Motor plate	Aluminum alloy	-
12	Lock nut	Special steel□	Chromate
13	Socket□	Carbon steel	Electroless nickel plated
14	Lead screw pulley	Aluminum alloy	-
15	Motor pulley	Aluminum alloy	-
16	Spacer	Stainless steel	LESH25R/L* only
17	Stopper	Carbon steel	Electroless nickel plated
18	Bearing	-	-
19	Belt	-	-
20	Grommet	Plastic	-
21	Simring□	Steel	-
22	Bushing	-	Dust proof only
23	Pulley gasket	NBR	Dust proof only
24	End gasket	NBR	Dust proof only
25	Scraper	NBR	Dust proof only
26	cover	Plastic	-
27	Return guide	Plastic	-
28	Scraper	Stainless steel and NBR	Linear guide
29	Steel ball	High carbon chrome bearing steel	-
30	Lock	-	With lock only

Maintenance parts/belt

Size	Part number
LESH8□	LE-D-1-1
LESH16□	LE-D-1-2
LESH25□	LE-D-1-3
LESH25□A	LE-D-1-4

Maintenance parts/grease

Parts	Order number
Table	GR-S-010(10g)
	GR-S-020(20g)

•LESH*D

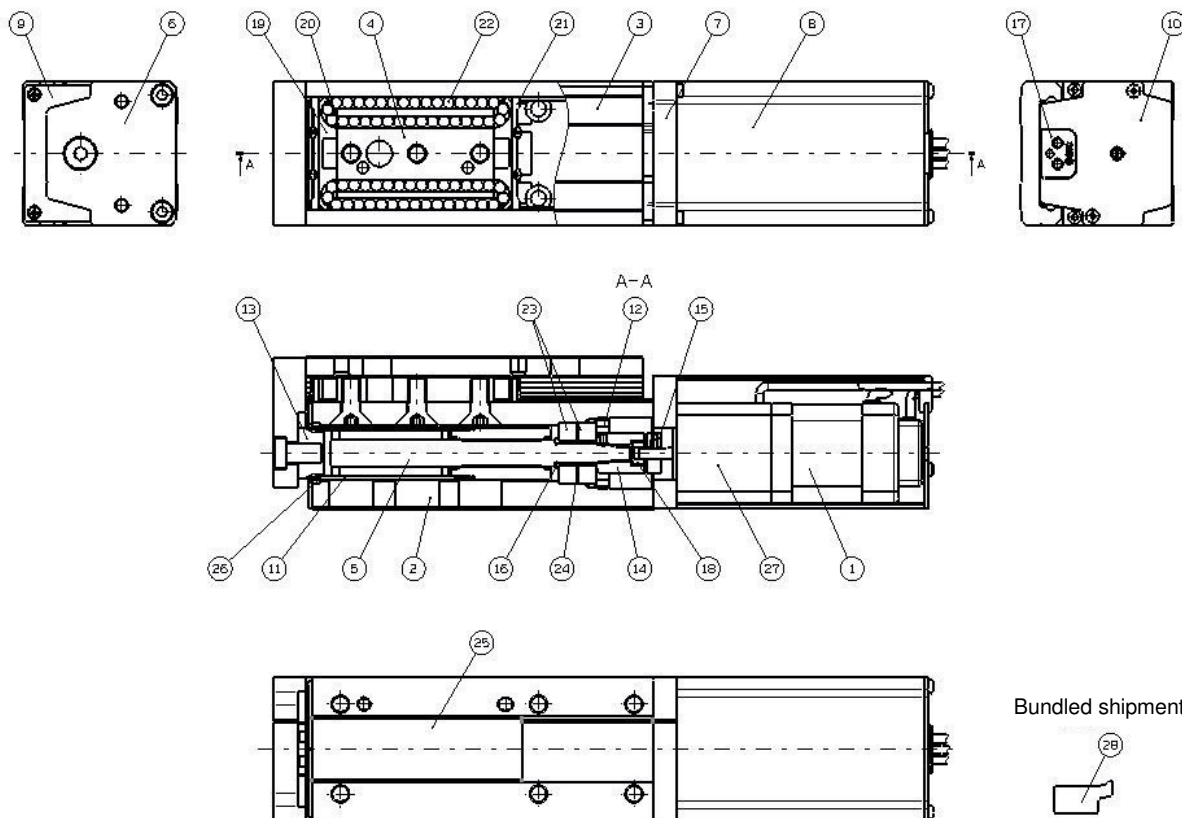

Component parts

No.	Description	Material	Remarks
1	Motor	-	-
2	Body	Aluminum alloy	Hard anodized
3	Table	Stainless steel	Heat treatment + Electroless nickel
4	Guide block	Stainless steel	Heat treatment
5	Lead screw	Stainless steel	Heat treatment + Special plated
6	End plate	Aluminum alloy	Hard anodized
7	Motor flange	Aluminum alloy	Hard anodized
8	Motor cover	Aluminum alloy	Hard anodized
9	End cover	Aluminum alloy	Hard anodized
10	Motor end cover	Aluminum alloy	Hard anodized
11	Rod	Stainless steel	-
12	Bearing holder	Carbon steel	Electroless nickel plated
		Copper alloy	Electroless nickel plated(LESH25R/L* only)
13	Socket	Carbon steel	Electroless nickel plated
14	Hub(Screw side)	Aluminum alloy	-
15	Hub(Motor side)	Aluminum alloy	-
16	Spacer	Stainless steel	LESH25D* only
17	Grommet	NBR	-
18	Spider	NBR	-
19	Cover	Plastic	-
20	Return guide	Plastic	-
21	Scraper	Stainless steel +	Linear guide part
22	Steel ball	Special steel	-
23	Bearing	-	-
24	Shim ring	Carbon steel	-
25	Masking tape	-	-
26	Scraper	NBR	Dust proof only / rod part
27	Lock	-	With lock only
28	Side Holder	Aluminum alloy	Hard anodized

Option parts/Side holder

Model	Part number
LESH8D	LE-D-3-1
LESH16D	LE-D-3-2
LESH25D	LE-D-3-3

Maintenance parts/grease

Parts	Order number
Table	GR-S-010(10g)
	GR-S-020(20g)

3. Product Outline

3.1 System construction

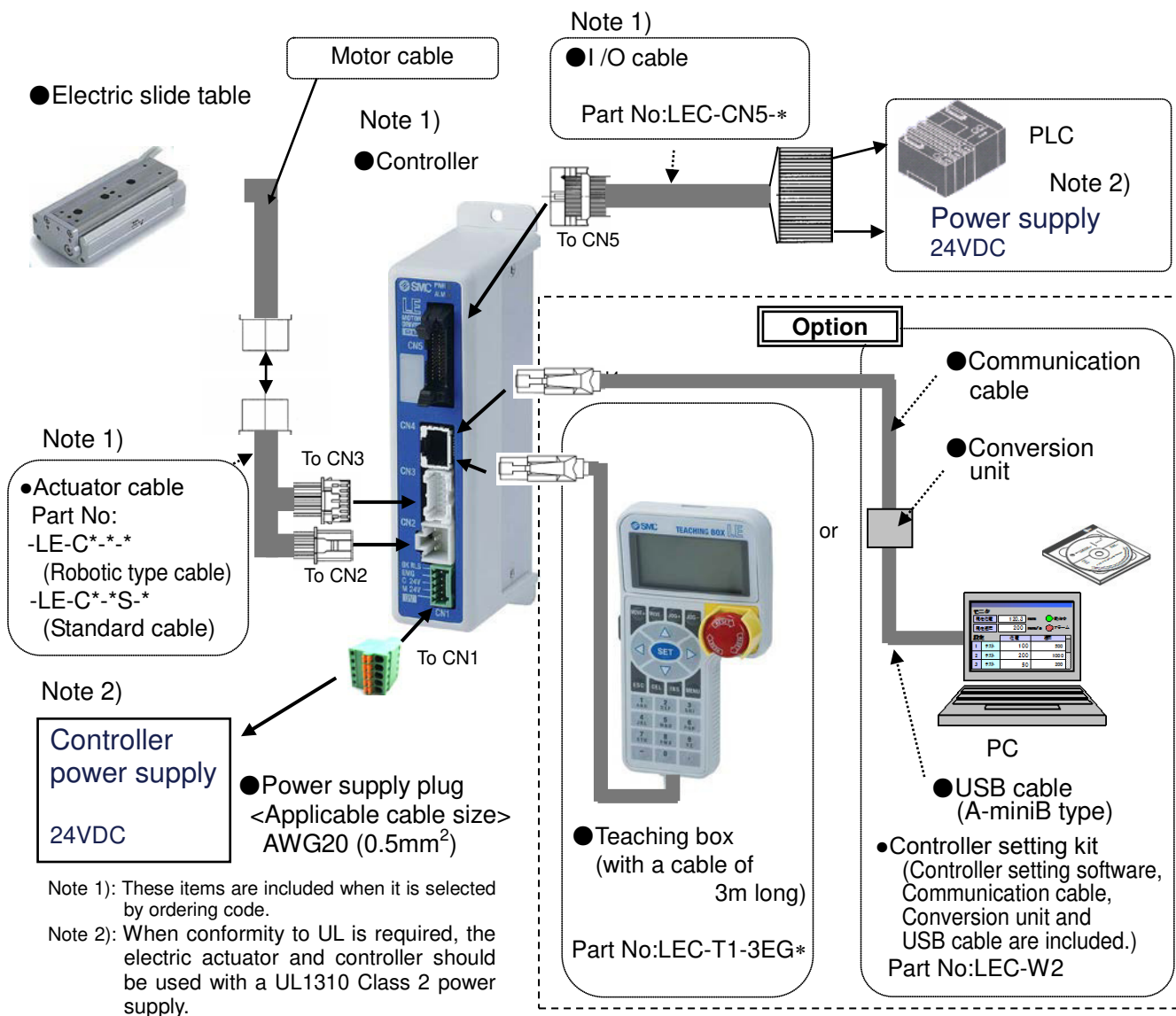

Warning

Refer to the operation manual of the LEC (controller) for detailed wiring.

/ See "4 Wiring of cables" on p.37.

Communication cable is to be connected to PC by USB cable through conversion unit. And do not connect teaching box to PC.

Do not connect the teaching box directly to the PC as there may be fire risk and damage to the PC or teaching box.

The actuator body and controller are sold as a package.

If when only the actuator is purchased separately, confirm that the combination of the controller, which you have and the actuator is compatible.

/See 5.3 ⚠ Caution(1) on p.40

<Be sure to check the following before use.>

- (1) Check that actuator label for model number. This matches the controller.
- (2) Check Parallel I/O configuration matches (NPN or PNP).

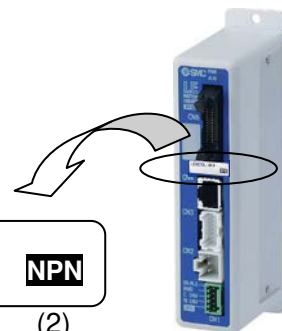
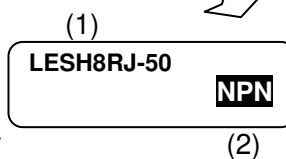

3.2 Setting Function

Refer to the operation manual of the controller (LEC series) for the detail of the setting function.

Easy Mode for simple setting

>Select “Easy mode” for instant operation

Controller setting software

- Setting and operation, such as the step data setting, test drive and JOG / fixed-distance moving, can be performed on the same page.

Annotations for the Easy Mode interface:

- JOG moving (points to Jog Speed field)
- Start testing (points to Drive button)
- Positioning data setting (points to Step data table)
- Fixed distance moving (points to Move distance field)
- Speed setting of JOG / fixed distance (points to Move Speed field)

Teaching box

- Setting and operation by the simple screen without scrolling.
- Select function by the iconized menu at the first page.
- Step data setting and monitoring at the second page.

1st screen

2nd screen

Data	Axis 1
Step No.	0
Posn	123.45mm
speed	400mm/s

It can be registered by “SET” after entering the values.

Example of setting the step data

1st screen

2nd screen

Monitor	Axis 1
Step No.	1
Posn	12.34mm
speed	50mm/s

Operation status can be checked

Example of checking the operation status

Normal mode for the detailed setting

> **Select “Normal mode” if the detailed setting are necessary.**

- Step data can be set in detail.
- Parameters can be set.
- Signals and terminal condition can be monitored.
- JOG and fixed distance movement, return to origin position, test operation and testing of compulsory output can be done.

Controller setting soft ware

- Every function, step data, parameter, monitor and teaching are indicated in a different window.

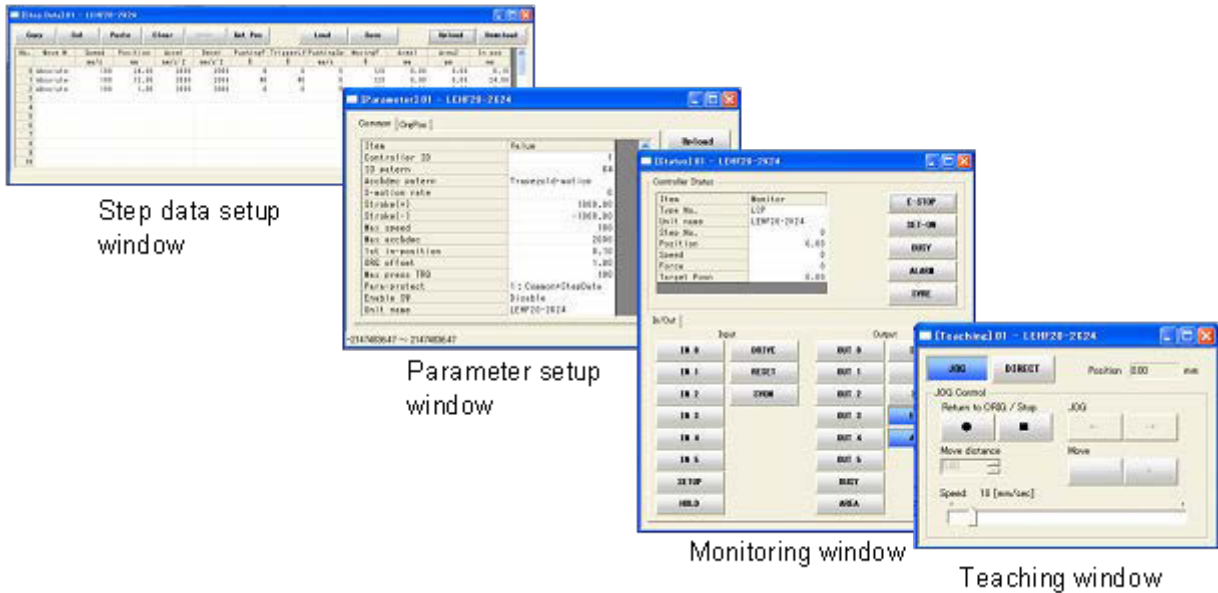

Teaching box

- The data in the controller can be saved / forwarded in this teaching box.
- Continuous test operation can be made after specifying five step data.

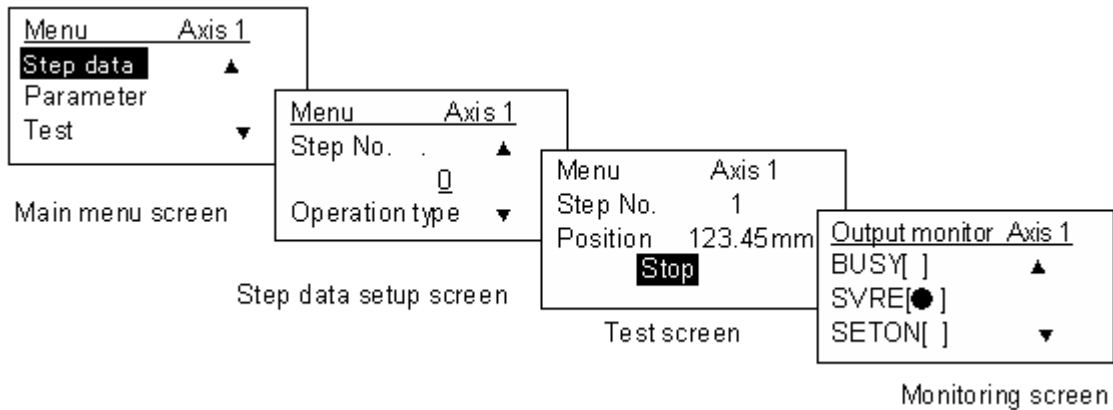

Controlled items

PC: Controller setting software TB: Teaching box
 ○: Available function ×: Not available function

Function		Content	Easy Mode		Normal mode
			PC	TB	PC/TB
Step data (Excerpt)	Movement method	It can be selected of absolute / relative position move	○	×	○
	Speed	It can be set by the unit of 1mm/s.	○	○	○
	Position	It can be set by the unit of 0.01mm.	○	○	○
	Acceleration Deceleration	It can be in units of 1mm/s ² .	○	○	○
	Pushing force	It can be set in units of 1% from 30% to 70%(Step motor). 50% to 100%(Servo motor) *LES[]RA:50% to 75% Positioning operation: Set to 0%.	○	○	○
	Trigger LV	Trigger LV of target force when pushing operation: It can be set by the unit of 1% from 30% to 70%(Step motor). 50% to 100%(Servo motor) *LES[]RA:50% to 75%	○	×	○
	Pushing speed	It can be set in units of 1mm/s. Minimum speed~20mm/s.	○	×	○
	Moving force	Step motor : 100%(Please do not change.) Servo motor : 250%(Please do not change.)	○	×	○
	Area output	It can be set in units of 0.01mm.	○	×	○
	In position	During positioning operation: Width to the target position. It should be set to 0.5 or more. During holding operation: How much it moves during holding operation.	○	×	○
Parameter (Excerpt)	Stroke(+)	+ side limit of position (It can be set in units of 0.01mm)	×	×	○
	Stroke(-)	- side limit of position (It can be set in units of 0.01mm)	×	×	○
	ORIG direction	Sets the direction of return to origin operation (CW / CCW)	×	×	○
	ORIG speed	Speed when returning to origin position can be set	×	×	○
	ORIG ACC/DEC	Acceleration when returning to origin position can be set.	×	×	○
Test	JOG	It can make continuous operation at the set speed while the switch is being pressed.	○	○	○
	MOVE	It can make test operation at the set distance and speed from the current position when the switch is pressed.	○	×	○
	Return to ORIG	Test of return to origin position can be done.	○	○	○
	Test drive	The operation of the specified step data can be tested.	○	○	○ (Continuous operation)
	Force output	ON/OFF of the output terminal can be tested.	×	×	○
Monitor	DRV mon	Current position, current speed, current thrust and the specified step data No. can be monitored.	○	○	○
	In/Out mon	Current ON/OFF status of the input and output terminal can be monitored.	×	×	○
ALM	Status	The alarm currently being generated can be confirmed, and be reset.	○	○	○
	ALM Log record	The alarm generated in the past can be confirmed.	×	×	○
File	Save-Load	The step data and parameter of the objective controller can be saved, forwarded and deleted.	×	×	○
Others	Language	Language can be changed to Japanese/English.	○ *3	○ *2	○ *2 *3

*1 Every parameter is set to the recommended condition before ex-factory. Change the setting of only the items which requires adjustment.

*2 Teaching box: It can be indicated in English. English and Japanese switch setting is only available in the normal mode.

*3 Controller setting software : It can be installed by selecting English version or Japanese version

3.3 Step data setting

Refer to the operation manual of the controller (LEC series) for details.

This operation manual specifies the electric slide table, if an actuator other than the electric slide table is used, refer to the operation manual of each type of actuator and controller (LEC series) regarding the description of step data.

Caution

The actuator body and controller are sold as a package.

If when only the actuator is purchased separately, confirm that the combination of the controller, which you have and the actuator is compatible. /See 5.3  Caution(1) on p.40

<Be sure to check the following before use.>

- (1) Check that actuator label for model number.
This matches the controller.
- (2) Check Parallel I/O configuration matches (NPN or PNP).

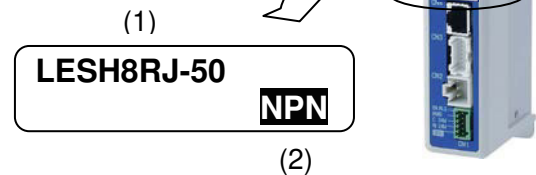

Positioning operation

In the positioning operation, the electric slide table transfers to and stops at the target position. The following image shows the set items and operation.

<Confirmation of reaching of target position at the positioning operation>

When the table of actuator reaches the range of the target position, the output signal 【INP】 (in position) is outputted.

When the table of actuator enters the range of 【in position】, the INP output signal turns on.

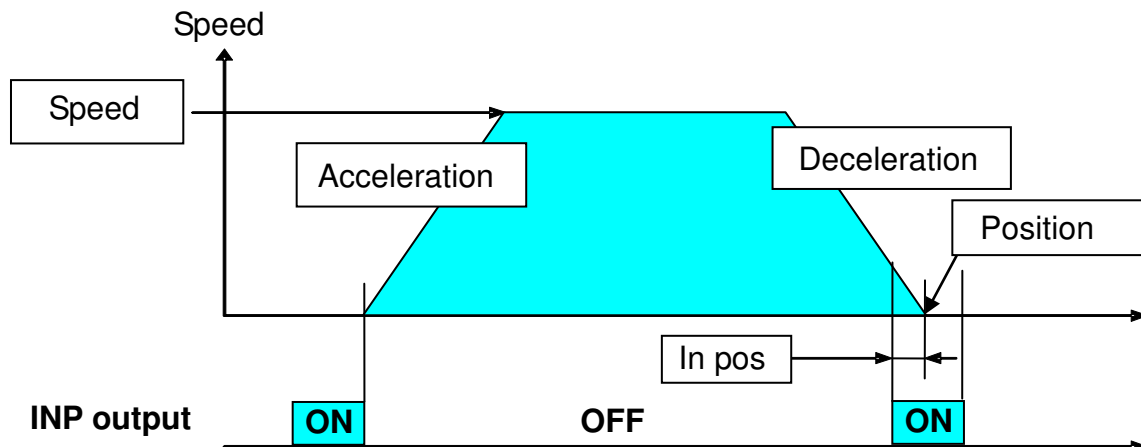

Caution

Please use by "Pushing Mode" when you make it Push or clamp.

The product might be damaged by the impact when using it by "Positioning Mode".

/ See 6.2  Caution(2) on p.43

<Items and set values in positioning operation>

Step No. 0: Positioning operation

	a	b	c	d	e	f	g	h	i	j		k
No.	Move M	Speed	Position	Accel	Decel	PushingF	TriggerLV	PushingSp	MovingF	Area1	Area2	In pos
		mm/s	mm	mm/s ²	mm/s ²	%	%	mm/s	%	mm	mm	mm
0	Absolute	400	50.00	5000	5000	0	0	20	100	48.00	50.00	0.50
1	Absolute	400	40.00	5000	5000	30	30	20	100	0.00	0.00	10.00

[◎] Need to be set - [○] Need to be adjusted as required- [×] Not used. Items don't need to be changed.

- a** < ◎ Movement MOD > When the absolute position is required, set Absolute
When the relative position is required, set Relative
→ Absolute: Distance from the origin position.
Relative: Feed from the current position.
- b** < ◎Speed > Transfer speed to the target position.
- c** < ◎Position > Target position.
- d** < ○ Acceleration > The parameter which defines how rapidly the actuator reaches the speed set in **b**
The higher the set value, the faster it reaches the speed set in **b**
- e** < ○ Deceleration > The parameter which defines how rapidly the actuator comes to stop.
The higher the set value, the quicker it stops.
- f** < ◎Pushing force > Set **0**.
(If values other than 0 set the operation will be changed to the pushing operation.)
- g** < × Trigger LV >
- h** < × Pushing speed >
- i** < × Moving force > Max. Force at the positioning operation.
The force is automatically adjusted corresponding to the load.
Step motor : Set [100] % (Please do not change)
Servo motor : Set[250]% (Please do not change)
- j** < ○Area1, Area2 > This is the condition that turns on the AREA output signal.
The setting condition should be **Area 1<Area 2**.
It is possible to set at relative operation.
The position will be Absolute (position from the origin).
Example) In case of Step no.0
[AREA] output signal is outputted between Area 1:48 and Area 2:50.
- k** < ○In position > This is the condition that turns on the INP (in position) output signal.
→When the electric slide table reaches the range of the target position, the INP output signal is output.
When the electric slide table enters the range of [in position], the INP output signal turns on.
When it is necessary to output the target position reaching signal earlier, make the value larger.
Note) Default: Set the value more than [0.50].
Example) In case of Step no.0
Position: 50 – In position: 0.5 = [INP] is outputted from the value of 49.5.

Pushing operation

The table move to the target position and hold a work piece with the set pushing force. The figure shows setting items and operation. The setting items and values are described below.

<Confirmation of reaching the target value during the pushing operation>

The target position reached signal INP (in position) is generated when the target pushing force (Trigger LV) is achieved.

Also, if the actual pushing force exceeds the Trigger LV, the INP signal is turned on.

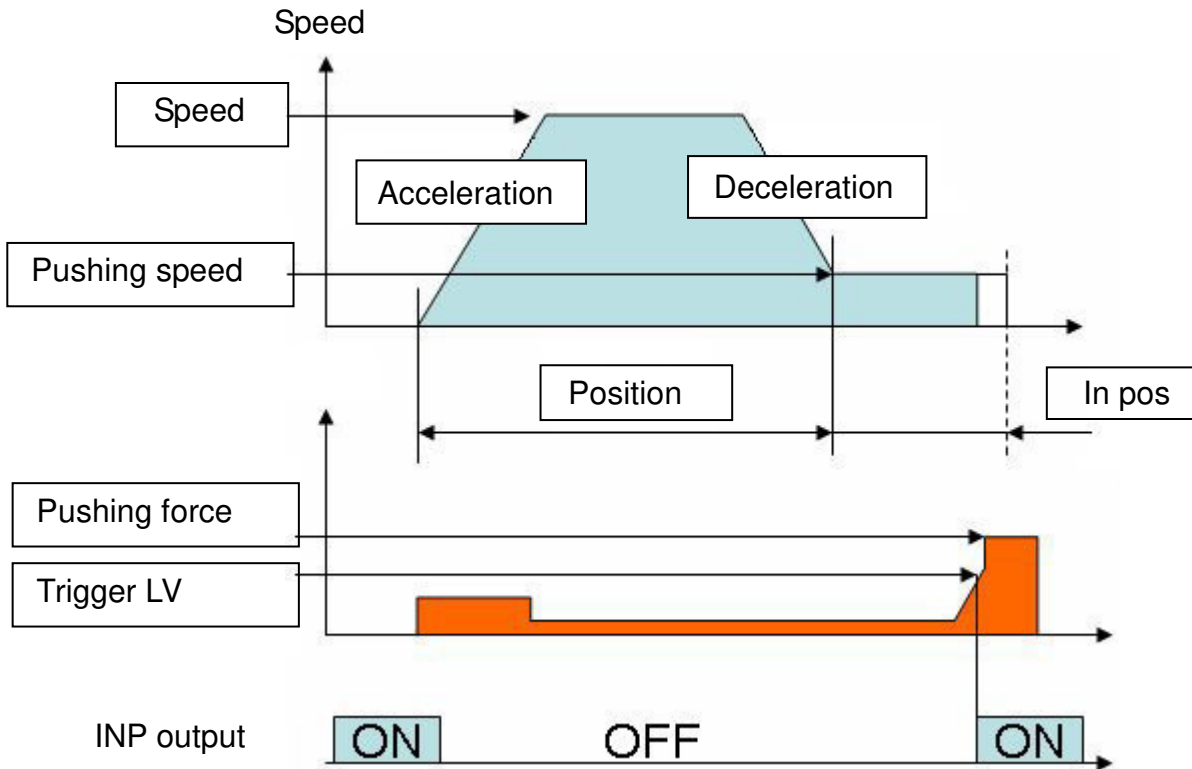

Caution

Please use it by "Pushing Mode" when you make it push or clamp.

The product might be damaged by the impact when using it by "Positioning Mode".

/ See 6.2  Caution(2) on p.43

<Items and setting values of pushing operation>

Step no. 1: Pushing operation

	a	b	c	d	e	f	g	h	i	j	k	
No.	Move M	Speed	Position	Accel	Decel	PushingF	TriggerLV	PushingSp	MovingF	Area1	Area2	In pos
		mm/s	mm	mm/s ²	mm/s ²	%	%	mm/s	%	mm	mm	mm
0	Absolute	400	50.00	5000	5000	0	0	20	100	48.00	50.00	0.50
1	Absolute	400	40.00	5000	5000	30	30	20	100	0.00	0.00	10.00

[◎] Need to be set - [○] Need to be adjusted as required - [×] Not used. Items don't need to be changed.

a < ◎ Movement MOD > When the absolute position is required, set Absolute
When the relative position is required, set Relative
Absolute: Distance from the origin position. Relative: Feed from the current position

b < ◎ Speed > Transfer speed to the target position

c < ◎ Position > Target position / The pushing starting position is set forward by 0.5mm or more of the pushing object.

d < ○ Acceleration > The parameter which defines how rapidly the actuator reaches the speed set In.
The higher the set value, the faster it reaches the speed set in.

e < ○ Deceleration > The parameter which defines how rapidly the actuator comes to stops.
The higher the set value, the quicker it stops.

F < ◎ Pushing force > Pushing force ratio is defined.

Note) :Step motor - Settable range 30 to 70 %

Pushing F(%)	Duty ratio (%)	Continuous pushing time (minute)
30	-	-
50 or less	30	5
70 or less	20	3

Note) :Servo motor-Settable range 50 to 100(75) %

Pushing F(%)	Duty ratio (%)	Continuous pushing time (minute)
50	-	-
75 or less	30	5
100 or less	20	3

e.g. If the pushing force is <50% the pushing time can be 5 minutes and the duty ratio of 30%.

- The pushing F of LES*8*A (servo motor) is up to 75% or less.

g < ◎ Trigger LV > The condition at which INP output signal is turned on. Set it below the pushing force setting value of the pushing force within the range.
The INP output signal is given when the target force (Trigger LV) is achieved.
The INP output signal is turned on when the generated force exceeds the value.
/ See 6.2▲Caution(1) on p.43

h < ◎ Pushing speed > The pushing speed whilst in pushing mode.

【Minimum speed~20 mm /s】 and 【Speed or more Pushing Speed】
(Please do not change)

The speed can be set from the specified minimum to a maximum of 20mm/s. If the speed is too high, the actuator or work piece can be damaged by impact.

i < × Moving force > The upper force limit for the pushing operation starting position
The force is automatically adjusted corresponding to the load.

j < ○ Area1, Area2 > This is the condition that turns on the AREA output signal.
The setting condition should be **Area 1<Area 2**.
It is possible to set at Relative operation.
The position will be Absolute (position from the origin).

k < ◎ In position > The transfer distance (relative value) when pushing
If the transferred distance exceeds the setting, it stops even if it is not pushing.
If the transfer distance is exceeded, the INP output signal will not be turned on.
(incomplete pushing)
Example) In case of Step no.1 / Position: 40 + In Position: 10 = 50
(The position where the incomplete pushing is detected.)

Example of step data entry (1)

< Positioning operation - 【INP】output signal, 【AREA】output signal >

No.	Move M	Speed mm/s	Position mm	Accel mm/s ²	Decel mm/s ²	PushingF %	TriggerLV %	PushingSp mm/s	MovingF %	Area1 mm	Area2 mm	In pos mm
0	Absolute	100	100.00	3000	3000	0	0	0	100	80.00	90.00	0.50

•Step data no.0 : Positioning operation (It moves from Position:0[mm] to Position:100[mm])

Condition 1) The 【AREA】output signal is not used.

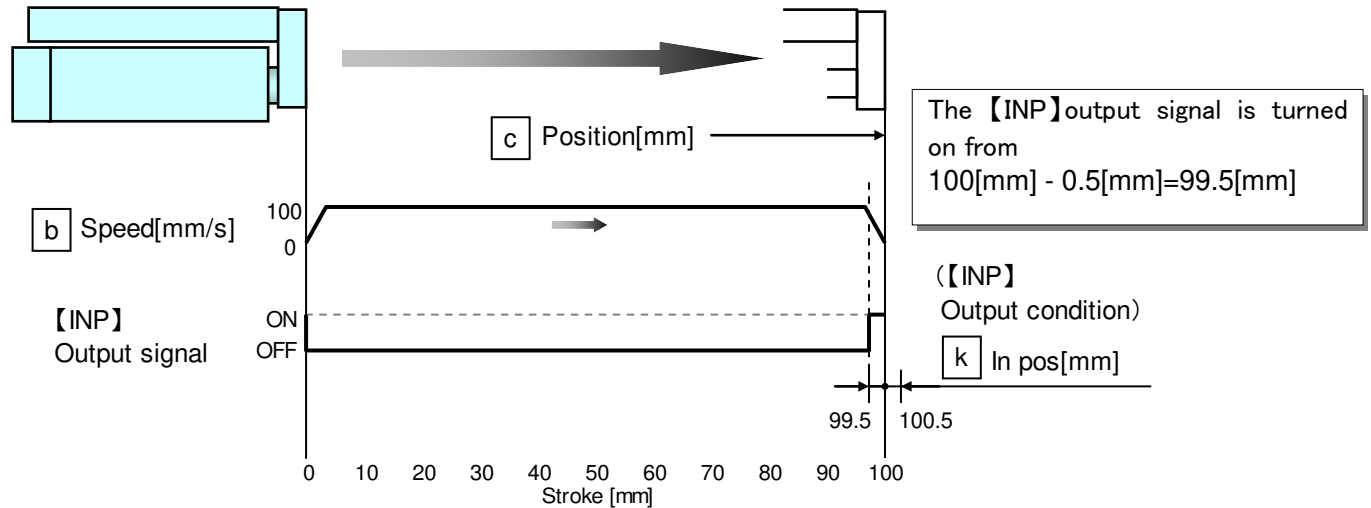

Condition 2) The 【AREA】output signal is used.

*The 【AREA】output signal is a signal output when the rod traverses through a certain range (The step data: **Area 2** from **Area 1**).

This feature is useful when an output to check the rod position at intermediate stroke is required.

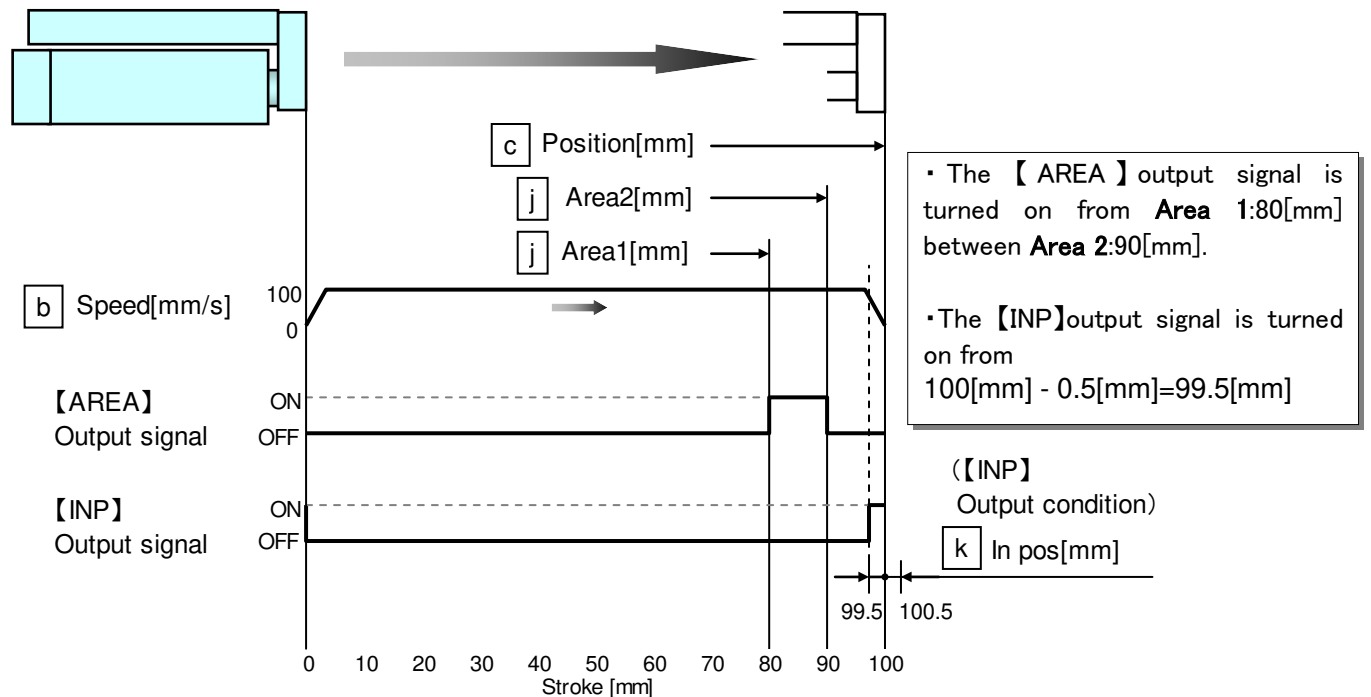

Example of step data entry (2)

< Pushing operation - 【INP】output signal, 【AREA】output signal >

No.	Move M	Speed mm/s	Position mm	Accel mm/s ²	Decel mm/s ²	PushingF %	TriggerLV %	PushingSp mm/s	MovingF %	Area1 mm	Area2 mm	In pos mm
0	Absolute	100	70.00	3000	3000	60	30	20	100	60.00	80.00	25.00

•Step data no.0 : Positioning operation. (It moves to 90mm after it moves from 0mm to 70mm.)

Condition 1) The 【AREA】output signal is not used.

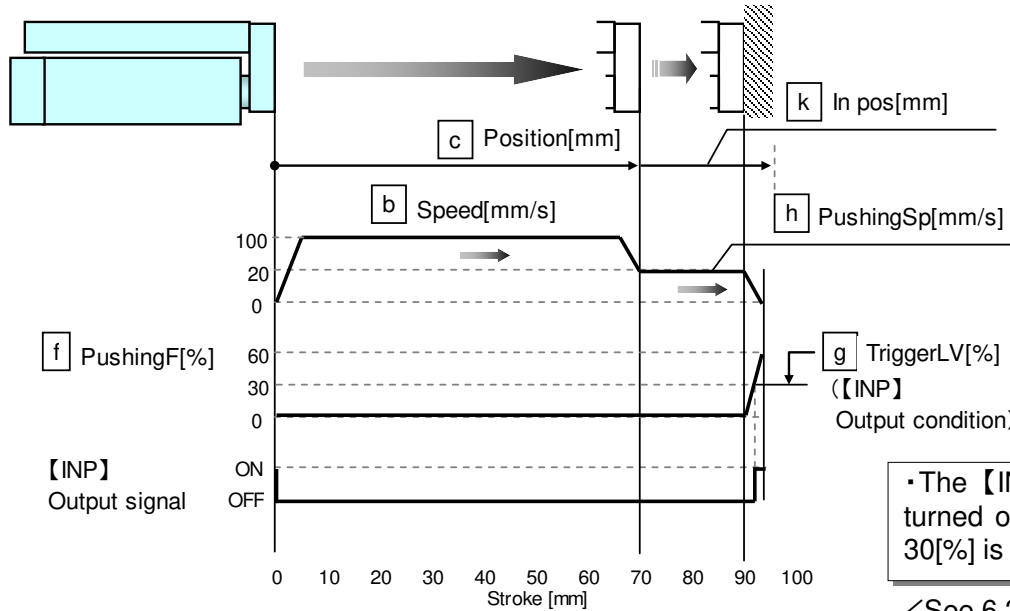

Condition 2) The 【AREA】output signal is used.

* The 【AREA】output signal is a signal output when the rod traverses through a certain range (The step data: **Area 2** from **Area 1**).

This feature is useful when an output to check the rod position at intermediate stroke is required.

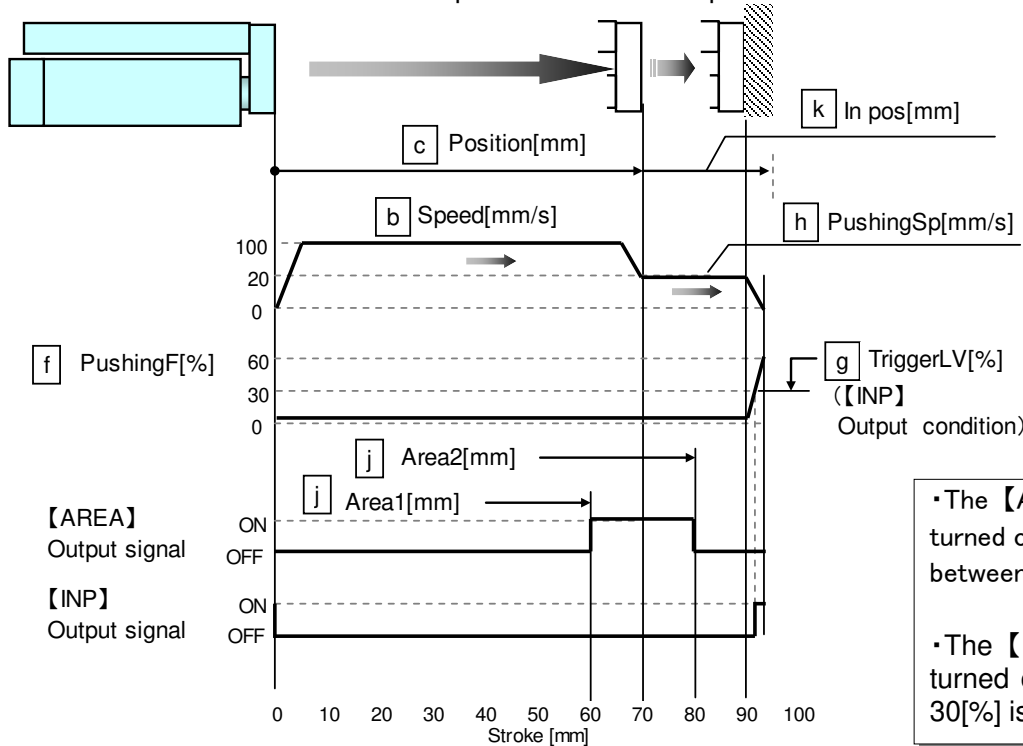

Example of step data entry (3)

< Positioning operation - Relative >

	a	b	c	d	e	f	g	h	i	j	k	
No.	Move M	Speed mm/s	Position mm	Accel mm/s ²	Decel mm/s ²	PushingF %	TriggerLV %	PushingSp mm/s	MovingF %	Area1 mm	Area2 mm	In pos mm
0	Relative	100	10.00	3000	3000	0	0	0	100	10.00	20.00	0.50
1	Relative	100	-10.00	3000	3000	0	0	0	100	10.00	20.00	0.50

*Absolute: Distance from the origin position.

*Relative: Feed from the current position.

Condition 1) 30mm position → **Step no.0** → **Step no.0** (Move M: Relative)

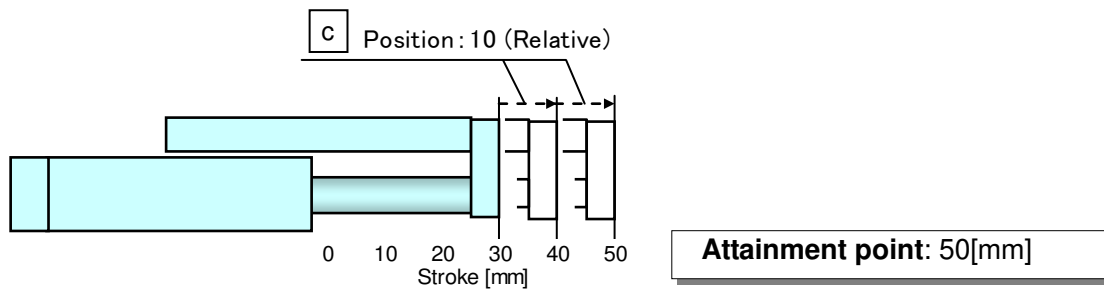

Condition 2) 30mm position → **Step no.1** → **Step no.1** (Move M: Relative)

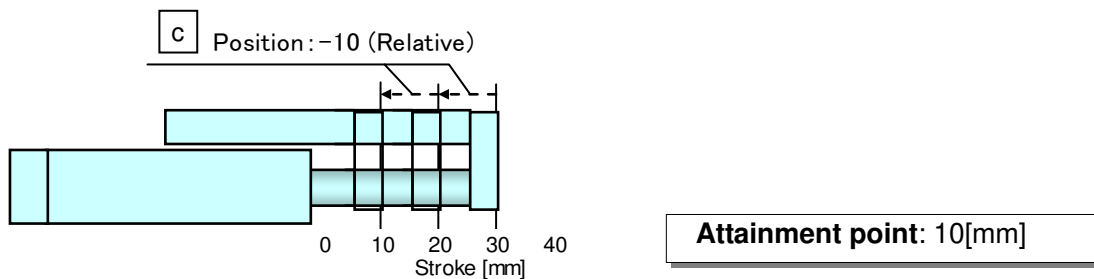

Example of step data entry (4)

< Pushing operation - In position >

	a	b	c	d	e	f	g	h	i	j	k	
No.	Move M	Speed	Position	Accel	Decel	PushingF	TriggerLV	PushingSp	MovingF	Area1	Area2	In pos
		mm/s	mm	mm/s ²	mm/s ²	%	%	mm/s	%	mm	mm	mm
0	Absolute	100	20.00	3000	3000	60	30	20	100	10.00	20.00	20.00

Step data no.0 : Pushing operation ("Pushing operation" is done during 20mm after it moves from 0mm to 20mm.)

Condition 1) Length to work < In position

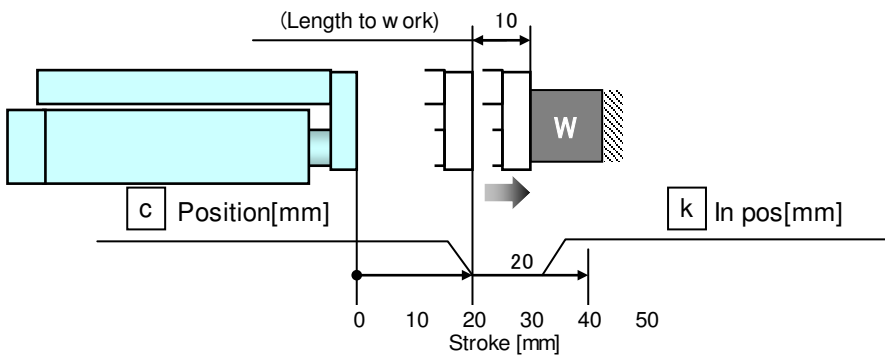

【INP】Output condition

- **k** In pos \geq Length to work
- Actual force \geq **g** TriggerLV

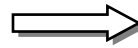

The 【INP】 output signal is turned on

Condition 2) Length to work > In position

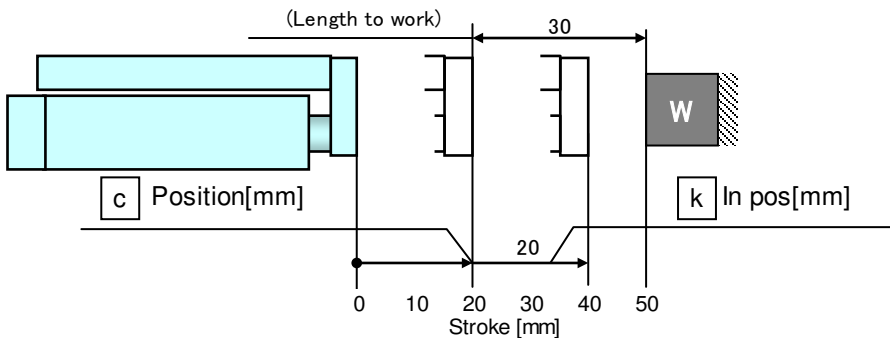

【INP】Output condition

- **k** In pos < Length to work
- Actual force < **g** TriggerLV



The 【INP】 output signal is not turned on
The 【BUSY】 output signal is turned off

Example of step data entry (5)

< Pushing operation – Driving starting position >

The pushing action is different and dependent upon the starting position and direction.
Confirm the position where the pushing operation starts.

	a	b	c	d	e	f	g	h	i	j	k	
No.	Move M	Speed mm/s	Position mm	Accel mm/s ²	Decel mm/s ²	PushingF %	TriggerLV %	PushingSp mm/s	MovingF %	Area1 mm	Area2 mm	In pos mm
0	Absolute	100	0.00	3000	3000	0	0	0	100	10.00	20.00	0.50
1	Absolute	100	50.00	3000	3000	0	0	0	100	10.00	20.00	0.50
2	Absolute	100	30.00	3000	3000	60	30	20	100	10.00	20.00	10.00

Condition 1) In case the pushing operation is **Step no.0** to **Step no.2**.

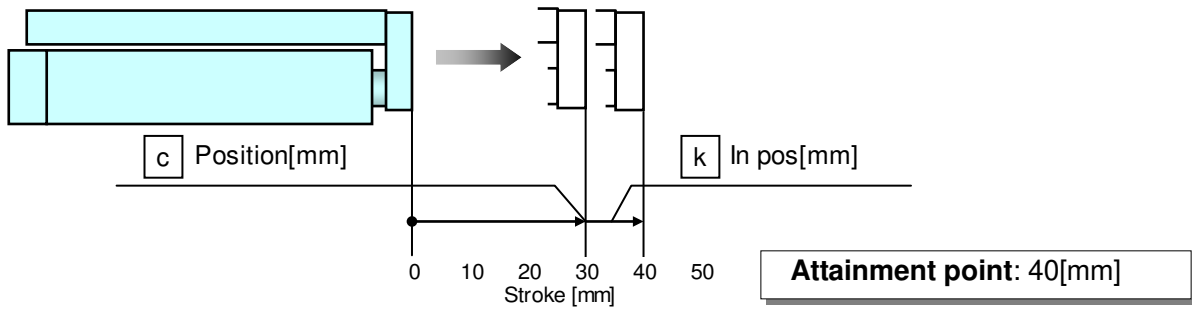

Condition 2) In case the pushing operation is **Step no.1** to **Step no.2**.

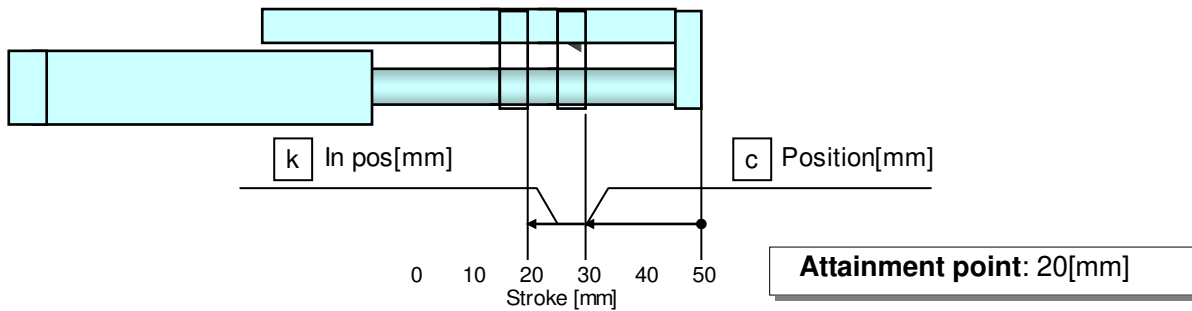

Operating procedure and input / output signals for each operation

The input / output signal and the operation description for operating this electric actuator are as follows.

1) Signals along with the operation procedures

In case the operation order is

1. Supply power to the motor → 2. Return to origin → 3. Step no. 1 → 4. Step no. 2 → 5. Cut power to the motor

Procedure	Input signal	Output signal to the input signal	Operation description
1	SVON(Servo on)[●]	SVRE(Servo ready) [●]	Power is supplied to the motor, and detection of the magnetic pole position. =Complete.
2	SETUP [●]	SETON [●] INP(IN position)[●]	Return to the origin. =Complete.
3	IN0 [●] IN1 [] IN2 [] IN3 [] IN4 [] IN5 [] ↓ DRIVE [●] [] note.3)5)	OUT0 [●] OUT1 [] OUT2 [] note3.4) OUT3 [] OUT4 [] OUT5 [] ↓ After reaching of target position, INP [●] After stopping motion BUSY []	Step no.1 is selected, and the operation starts. =Completion.
4	IN0 [] IN1 [●] IN2 [] IN3 [] IN4 [] IN5 [] ↓ DRIVE [●] ⇒ [] note.3)5)	OUT0 [] OUT1 [●] OUT2 [] note.3.4) OUT3 [] OUT4 [] OUT5 [] ↓ After reaching of target position INP [●] After stopping motion BUSY []	Select the step no. 2, and the operation starts. =Complete.
5	SVON []	SVRE [] SETON [●] note.2) INP [●]	Power to the motor is removed.

Note 1) [●] means ON, [] means OFF.

Note 2) The origin has been recognized when the operation is repeated, so it can operate without the procedure item 2.

Note 3) The out* signals are reset on the rising edge of the Drive signal. The Out* signal are latched with the data from the IN* data on the falling edge of the drive pulse.

Note 4) When the alarm is generated, the alarm group is displayed by the combination of output signal, "OUT*".

Please confirm controller (LEC series) manual to a detailed content of the alarm.

Note 5) Leave an interval of 15ms (the recommendation is 30ms) or more between input signals and maintain the state of the signal for 15ms (the recommendation is 30ms) or more, because PLC processing delays and controller scanning delays can occur.

2) Signals when Stopped: In the event when “EMG” is used

/ See 5.1 Warning (9) on p. 38

The operating sequence is **1.”Stop”** → **2.Release the “Stop”**

Procedure	Input signal	Output signal to the input signal	Operation description
1	EMG:Not energizing (TB / Stop switch:Locking)	* ESTOP[] SVRE [] SETON [●]	Power to the motor is cut by the “Stop” command regardless of whether it is operating or stopping.
2	EMG: Energizing (TB / Stop switch: Releasing	* ESTOP[●] SVRE [●] SETON [●] Note 2)	The stop is released.

Note 1) [●] means ON, [] means OFF. *means negative logic

Note 2) SETON signal does not change after releasing the “STOP”.

Note 3) If the stop is input from the EMG or RESET terminal or the stop-switch on the connected Teaching Box during pushing operation, the actuator stop.
 (“Busy”signal turns OFF) And if the actuator stop within the range of “Position”± “In pos” defined in step data,output signal “INP” turns ON.

3.4 Parameter setting

Initial setting for the basic parameters

Refer to the controller's (LEC series) operation manual for detail.

As the "basic parameter" is unique data of each actuator, if an actuator other than the electric slide table

Description (Extract)	Initial input value	Input range
Controller ID	1	1 to 64 Note 1)
IO pattern	1:64	-
Acceleration / deceleration pattern	1: Trapezoid - motion	-
S-motion ratio	0	-
Stroke (+) note2) 3) 4)	Product stroke +1	10000
Stroke (-) note2) 3) 4)	-1.00	-10000
Maximum speed	Max. speed of each product	Step data input limit: Max. speed of each product
Maximum acceleration / deceleration	5000	to 5000
Default In positioning	0.5	0.5 to product stroke
Origin offset note4)	0.00	Not changeable
Maximum pushing force	70 (LES***)	30 to 70
	75(LES*8*A)	50 to 75
	100 (LES*16*A,LES*25*A)	50 to 100
Parameter protect	1: Common + StepData	Changeable parameter 1: Common + StepData, 2: Common
Enable switch	2: Disable	Select 1:Enable or 2:Disable when using a teaching box
Model name	Part no. of each product	Only the English characters and numbers are changeable.
W-area output end 1	0.00	-
W-area output end 2	0.00	-
Origin correction data	0.00	-

Note1) Become effective after restarting the controller.

Note2) The table operating range of the actuator is shown.

Make the set point Stroke (-) to Stroke (+) is reduced more than Product stroke + 2.

Note3) Positioning operation, Pushing operation, and JOG operation are moved within the range of Stroke (-) to Stroke (+). The alarm is generated if it sets it outside the setting.

Note4) Change Stroke (-) and Stroke (+) when you change Direction of return to origin and Origin offset.

/ See "Return to origin" on P.34

/ See "Origin offset" on P.36

Initial setting for the ORIG parameters

Refer to the controller's (LEC series) operation manual for detail.

As the "basic parameter" is unique data of each actuator, if an actuator other than the electric slide table is used, refer to the operation manual of each actuator and the controller's (LEC series) operation manual for the ORIG parameter.

Description (Extract)	Initial input value	Input range
ORIG direction	Note1) 2:CCW	1: CW , 2: CCW
ORIG mode	1: ORIG Press	-
ORIG limit	LES***:100	-
	LES***A:250	-
ORIG time	100	-
ORIG speed	LES***K:10~20、 LES***J:20	-
ORIG ACC /DEC	100	-
Creep speed	10	-
ORIG sensor	0: Disable	-

Note1) CCW direction: Extended CW direction: Retracted.
Become effective after restarting the controller.

Note2) Return to origin cannot return while operating / See 5.1 ⚠ Caution(4) on p.39

<Return to origin>

Before the positioning and pushing operation, "return to origin" is necessary to establish the origin.

The current position value of the electric slide table increases if the table move (move in the CW direction).

(The default value of CW table moving direction cannot be increased.)

1) Sequence of return to origin

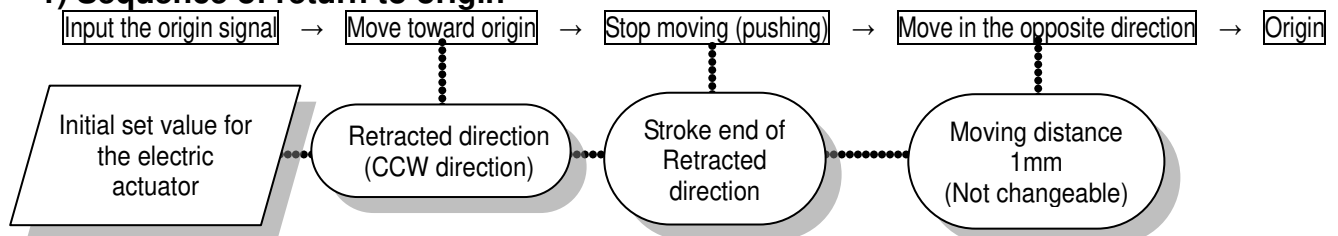

⚠ WARNING

Do not alter any parameter except the ones shown. Or else there is a possibility of damage.

2) Method of changing direction of origin

Use the following procedures when you change the direction of the origin.

Procedure 1- In the [Parameter] 01 dialogue box select the ORIG tab.

And the direction of the starting point return is changed from CCW to CW.

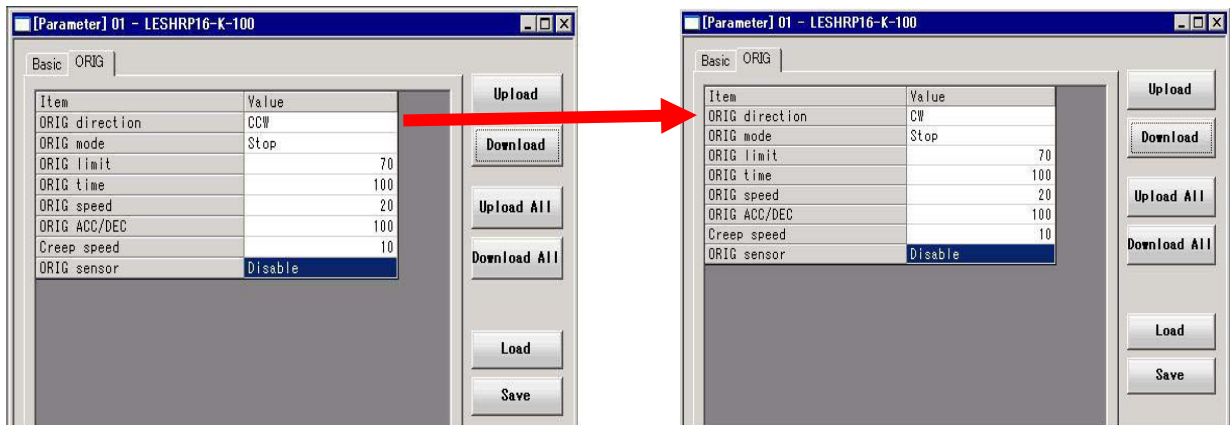

Procedure 2-

In the [Parameter] 01 dialogue box select the BASIC tab.

Alter stroke (- /+) as per the following example.

Example) For a product with stroke 50mm

Stroke (-): enter [-51]

Stroke (+): enter [1]

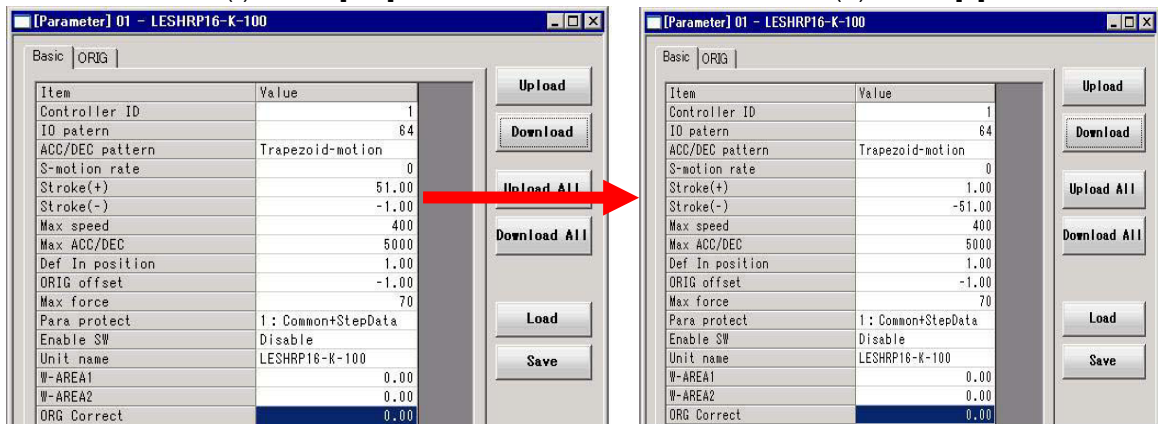

Procedure 3-

In the [Parameter] 01 dialogue box press the "Download All" radio button.

Procedure 4-

Power supply OFF (→ Power supply ON)

<Origin offset>

The origin offset means the value of the origin. (Origin offset=origin)

When the parameter is changed, the current position is changed. The step data should be checked again. In addition, the value of basic parameter "stroke (+)" and "Stroke (-)" changed.

Example of setting origin offset) Actuator stroke 75mm

Origin offset "0"

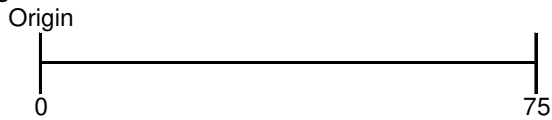

Origin offset "10"

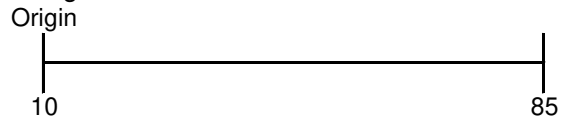

1. About the change in the basic parameter

When the origin offset is changed, it is necessary basic parameter **"Stroke (+) and stroke (-)"** to change.

1.1 Origin direction: CCW

Example) Actuator stroke 75mm

Origin offset=0

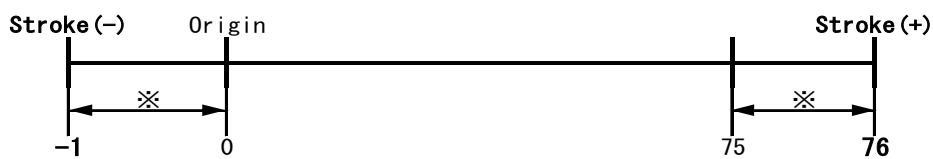

Origin offset=10

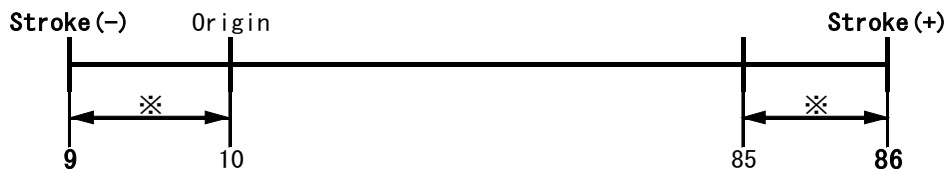

1.2 Origin direction: CW

Example) Actuator stroke 75mm

Origin offset=0

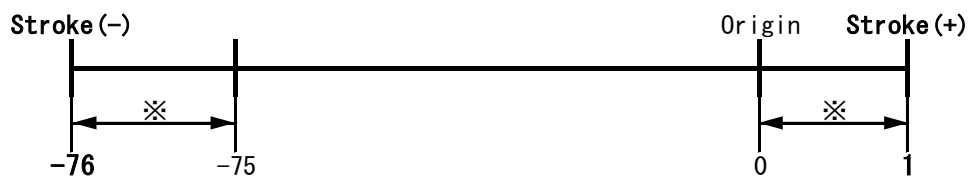

Origin offset=10



Origin offset=-10

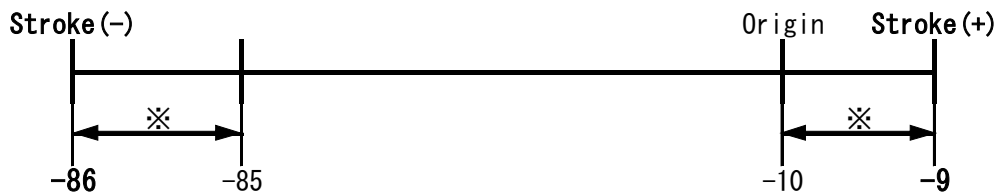

4. Wiring of cables / Common precautions

⚠ Warning

1. **Adjusting, mounting or wiring change should never be done before shutting off the power supply to the product.**
Electrical shock, malfunction and damaged can result.
2. **Never disassemble the cable. Use only specified cables.**
3. **Never connect or disconnect the cable or connector with power on.**

⚠ Caution

1. **Wire the connector securely. Do not apply any voltage to the terminals other than those specified in the product manual.**
2. **Wire the connector securely.**
Check for correct connector wiring and polarity.
3. **Take appropriate measures against noise.**
Noise in a signal line may cause malfunction. As a countermeasure, separate high voltage and low voltage cables, and shorten wiring lengths, etc.
4. **Do not route wires and cables together with power or high voltage cables.**
The product can malfunction due to interference of noise and surge voltage from power and high voltage cables to the signal line. Route the wires of the product separately from power or high voltage cables.
5. **Take care that actuator movement does not catch cables.**
6. **Operate with cables secured. Avoid bending cables at sharp angles where they enter the product.**
7. **Avoid twisting, folding, rotating or applying an external force to the cable.**
Risk of electric shock, wire break, contact failure and loss of control for the product can happen.
8. **Fix the cable protruding from the product in place before using.**
The motor and lock cables are not robotic type cables and can be damaged when moved. Therefore fix the cables and the connectors (part "A" in figure below) when set up.

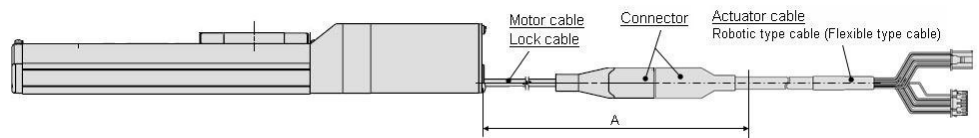

9. **Select "Robotic type cables" in case of inflecting actuator-cable repeatedly. And do not put cables into a flexible moving tube with a radius smaller than the specified value. (Min. 50mm).**
Risk of electric shock, wire break, contact failure and loss of control for the product can happen if "Standard cables" are used in case of inflecting the cables repeatedly.

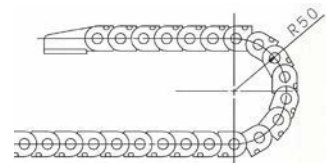

10. **Confirm proper wiring of the product.**
Poor insulation (interference with other circuits, poor insulation between terminals and etc.) can apply excessive voltage or current to the product causing damage.
11. **The Speed / pushing force may vary, depending on the cable length, load and mounting conditions etc.**
If the cable length exceeds 5m, the speed / pushing force will be reduced 10% per 5m as the maximum.
(If cable length is 15m: 20% reduction as the maximum.)

[Transportation]

⚠ Caution

1. **Do not carry or swing the product by the motor or cable.**

5. Electric actuators / Common precautions

5.1 Design and selection

Warning

- 1. Be sure to read the operation manual (this manual and the one for the controller: LEC series).**

Handling or usage/operation other than that specified in the Operation Manual may lead to breakage and operation failure of the product.
Any damage attributed to the use beyond the specifications is not guaranteed.
- 2. There is a possibility of dangerous sudden action by the product if sliding parts of machinery are twisted due to external forces etc.**

In such cases, human injury may occur, such as by catching hands or feet in the machinery, or damage to the machinery itself may occur. Design the machinery should be designed to avoid such dangers.
- 3. A protective cover is recommended to minimize the risk of personal injury.**

If a driven object and moving parts of the product are in close proximity, personal injury may occur. Design the system to avoid contact with the human body.
- 4. Securely tighten all stationary parts and connected parts so that they will not become loose.**

When the product operates with high frequency or is installed where there is a lot of vibration, ensure that all parts remain secure.
- 5. Consider a possible loss of power source.**

Take measures to prevent injury and equipment damage even in the case of a power source failure.
- 6. Consider behavior of emergency stop of whole system.**

Design the system so that human injury and/or damage to machinery and equipment will not be caused, when it is stopped by a safety device for abnormal conditions such as a power outage or a manual emergency stop of whole system.
- 7. Consider the action when operation is restarted after an emergency stop or abnormal stop of whole system.**

Design the system so that human injury or equipment damage will not occur upon restart of operation of whole system.
- 8. Never disassemble or modify (including additional machining) the product.**

An injury or failure can result. It will cause the loss of the product performance.
- 9. Do not use the stop signal, "EMG" of the controller and stop switch on the teaching box as the emergency stop of system.**

The stop signal, "EMG" of controller and the stop switch on the teaching box are for decelerating and stopping the actuator.
Design the system with an emergency stop circuit which is applied relevant safety standard separately.
- 10. When using it for vertical application, it is necessary to build in a safety device.**

The table may fall due to the weight of work. The safety device should not interfere with normal operation of the machine.

Caution

- 1. Operate within the limits of the maximum usable stroke.**

The product will be damaged if it is used with the stroke which is over the maximum stroke. Refer to the specifications of the product.
- 2. When the product repeatedly cycles with partial strokes, operate it at a full stroke at least once a day or every 1000 strokes.**

Otherwise, lubrication can run out.

- 3. Do not use the product in applications where excessive external force or impact force is applied to it.**

The product can be damaged. Each component that includes motor is made with accurate tolerance. So even slightly deformed or miss-alignment of component may lead operation failure of the product.

- 4. Returning to origin cannot be done during the operation.**

It cannot be done during positioning operation, pushing operation and pushing.

- 5. Refer to a common auto switch /matter (Best Pneumatics No 2) when an auto switch is built in and used.**

- 6. When conformity to UL is required, the electric actuator and controller should be used with a UL1310 Class 2 power supply.**

5.2 Mounting

Warning

- 1. Install and operate the product only after reading the Operation Manual carefully and understanding its contents.**

- 2. Observe the tightening torque for screws.**

Unless stated otherwise, tighten the screws to the recommended torque for mounting the product.

- 3. Do not make any alterations to this product.**

Alterations made to this product may lead to a loss of durability and damage to the product, which can lead to human injury and damage to other equipment and machinery.

- 4. When using external guide, the guide axis should be parallel to the actuator axis.**

There will be damage/excessive wear on the lead screw if the external guide is not parallel.

- 5. When an external guide is used, connect the moving parts of the product and the load in such a way that there is no interference at any point within the stroke.**

Do not scratch or dent the sliding parts of the product tube or piston rod etc., by striking or grasping them with other objects. Components are manufactured to precise tolerances, so that even a slight deformation may cause faulty operation.

- 6. Prevent the seizure of rotating parts.**

Prevent the seizure of rotating parts (pins, etc.) by applying grease.

- 7. Do not use the product until you verify that the equipment can operate properly.**

After mounting or repair, connect the power supply to the product and perform appropriate functional inspections to check it is mounted properly.

- 8. Cantilever**

When the actuator is operated at high speed while it is fixed at one end and free at the other end (flange type, foot type, double clevis type, direct mount type), a bending moment may act on the actuator due to vibration generated at the stroke end, which can damage the actuator. In such a case, install a support bracket to suppress the vibration of the actuator body or reduce the speed so that the actuator does not vibrate. Use a support bracket also when moving the actuator body or when a long stroke actuator is mounted horizontally and fixed at one end.

- 9. When mounting the actuator or attaching to the work piece, do not apply strong impact or large moment.**

If an external force over the allowable moment is applied, it may cause looseness in the guide unit, an increase in sliding resistance or other problems.

- 10. Maintenance space**

Allow sufficient space for maintenance and inspection.

5.3 Handling

Warning

1. Do not touch the motor in operation.

The surface temperature of the motor can increase to approx. 80°C due to operating conditions. This temperature increase may also be caused by energizing alone. As it may cause burns, do not touch the motor when in operation.

2. If abnormal heating, smoking or fire, etc., occurs in the product, immediately shut off the power supply.

3. Immediately stop operation if abnormal operation noise or vibration occurs.

If abnormal operation noise or vibration occurs, the product may have been mounted incorrectly. Unless operation of the product is stopped for inspection, the product can be seriously damaged.

4. Never touch the rotating part of the motor while in operation.

5. When installing, adjusting, inspecting or performing maintenance on the product, controller and related equipment, be sure to shut off the power supply to them. Then, lock it so that no one other than the person working can turn the power on, or implement measures such as a safety plug.

6. In the case of the actuator that has a servo motor (24VDC), the "motor phase detection step" is done by inputting the servo on signal just after the controller power is turned on.

The "motor phase detection step" moves the table/rod for the distance of the one screw-lead as the maximum. (The motor rotates in the reverse direction if the table hits an obstacle such as the end stop damper.) Take the "motor phase detection step" into consideration for the installation and operation of this actuator.

Caution

1. Keep the controller and product combined as delivered for use.

The product is set in parameters for shipment. If it is combined with a different parameter, failure can result.

2. Check the product for the following points before operation.

- a) Damage to power supply line and signal line.
- b) Looseness of the connector to each power line and signal line.
- c) Looseness of the actuator /cylinder and controller /driver mounting
- d) Abnormal operation
- e) Emergency stop of the total system

3. When more than one person is performing work, decide on the procedures, signals, measures and resolution for abnormal conditions before beginning the work. Also, designate a person to supervise work other than those performing work.

4. Actual speed of the product will be changed by the workload.

Before selecting a product, check the catalog for the instructions regarding selection and specifications.

5. Do not apply a load, impact or resistance in addition to a transferred load during return to origin.

In the case of the return to origin by pushing force, additional force will cause displacement of the origin position since it is based on detected motor torque.

6. Do not remove the nameplate.

7. Operation test should be done by low speed. Start operation by predefined speed after confirming there is no trouble.

[Earth]

Warning

1. Please give the earth to the actuator.

2. **Please make it to the earth of exclusive use. The earth construction is D seed.**
(Below earth resistance 100Ω)
3. **Please shorten the distance until the actuator and earth.**

[Unpackaging]

Caution

1. **Check the received product is as ordered.**

If the different product is installed from the one ordered, injury or damage can result.

5.4 Operating environment

Warning

1. **Avoid use in the following environments.**

- a. Locations where a large amount of dusts and cutting chips are airborne.
- b. Locations where the ambient temperature is outside the range of the temperature specification (refer to specifications).
- c. Locations where the ambient humidity is outside the range of the humidity specification (refer to specifications).
- d. Locations where corrosive gas, flammable gas, sea water, water and steam are present.
- e. Locations where strong magnetic or electric fields are generated.
- f. Locations where direct vibration or impact is applied to the product.
- g. Areas that are dusty, or are exposed to splashes of water and oil drops.
- h. Areas exposed to direct sunlight (ultraviolet ray).

2. **Do not use in an environment where the product is directly exposed to liquid, such as cutting oils.**

If cutting oils, coolant or oil mist contaminates the product, failure or increased sliding resistance can result.

3. **Install a protective cover when the product is used in an environment directly exposed to foreign matters such as dust, cutting chips and spatter.**

Play or increased sliding resistance can result.

4. **Shade the sunlight in the place where the product is applied with direct sunshine.**

5. **Shield the product if there is a heat source nearby.**

When there is a heat source surrounding the product, the radiated heat from the heat source can increase the temperature of the product beyond the operating temperature range. Protect it with a cover, etc.

6. **Grease oil can be decreased due to external environment and operating conditions, and it deteriorates lubrication performance to shorten the life of the product.**

[Storage]

Warning

1. **Do not store the product in a place in direct contact with rain or water drops or is exposed to harmful gas or liquid.**
2. **Store in an area that is shaded from direct sunlight and has a temperature and humidity within the specified range (-10°C to 60°C and 90%RH or less No condensation or freezing).**
3. **Do not apply vibration and impact to the product during storage.**

5.5 Maintenance

Warning

1. **Do not disassemble or repair the product.**

Fire or electric shock can result. Contact SMC, in case of disassembly for the maintenance.

2. **Before modifying or checking the wiring, the voltage should be checked with a tester 5 minutes after the power supply is turned off.**

Electrical shock can result.

 **Caution**

1. Maintenance should be performed according to the procedure indicated in the Operating Manual.

Improper handling can cause an injury, damage or malfunction of equipment and machinery.

2. Removal of product

When equipment is serviced, first confirm that measures are in place to prevent dropping of work pieces and run-away of equipment, etc, and then cut the power supply to the system. When machinery is restarted, check that operation is normal with actuators in the proper positions.

[Lubrication]

 **Caution**

1. The product has been lubricated for life at manufacturer, and does not require lubrication in service.

When lubrication is applied, special grease must be used. / See "2.3 Construction" on p.14-17
/ See "6.5 How to spreading grease" on p.51

5.6 Precautions for actuator with lock

 **Warning**

1. Do not use the lock as a safety lock or a control that requires a locking force.

The lock used for the product with a lock is designed to prevent dropping of work piece.

2. For vertical mounting, use the product with a lock.

If the product is not equipped with a lock, the product will move and drop the work piece when the power is removed.

3. "Measures against drops" means preventing a work piece from dropping due to its weight when the product operation is stopped and the power supply is turned off.

4. Do not apply an impact load or strong vibration while the lock is activated.

If an external impact load or strong vibration is applied to the product, the lock will lose its pushing force and damage to the sliding part of the lock or shortening of lifespan can result. The same situations will happen when the lock slips due to a force over the thrust of the product, as this accelerates the wear to the lock.

5. Do not apply liquid or oil and grease to the lock or its surrounding.

When liquid or oil and grease are adhered to the sliding part of the lock, its holding force will reduce significantly. Or, lock sliding part performance and condition changes may be cause of lock release malfunction.

6. Take measures against drops and check that safety is assured before mounting, adjustment and inspection of the product.

If the lock is released with the product mounted vertically, a work piece can drop due to its weight.

7. When the actuator is operated manually (when SVRE output signal is off), supply 24DCV to the [BK RLS] terminal of the power supply connector.

If the product is operated without releasing the lock, wearing of the lock sliding surface will be accelerated, causing reduction in the holding force and the life of the locking mechanism.

8. Do not supply 24VDC power supply constantly to the [BK RLS(Lock release)] terminal.

Stop supplying 24VDC power supply to the [BK RLS(Lock release) terminal during normal operation. If power is supplied to the [BK RLS] terminal continuously, the lock will be released, and workpieces may be dropped at stop (EMG).

/Refer to the operation manual of LEC (controller) for details of wiring.

6. Electric actuators / Common precautions

6.1 Design and selection

Warning

1. **Do not apply a load in excess of the actuator specification.**

A product should be selected based on the maximum pay load and allowable moment. If the product is used outside of the operating limit, eccentric load applied to the guide will become excessive and have adverse effects such as creating play at the guide, degraded accuracy and shortened product life.

2. **Do not use the product in applications where excessive external force or impact force is applied to it.**

This can lead to premature failure of the product..

6.2 Handling

Caution

1. **INP output signal**

1) **Positioning operation**

When the product comes within the set range by **step data [In position]**, output signal will be turned on.

Initial value: Set to [0.50] or higher.

2) **Pushing operation**

When the pushing force exceeds the [TriggerLV] value the INP (In position) output signal is turned on. Please set the [Pushing force] and the [TriggerLV] within the specified range.

To ensure that the actuator pushes the workpiece by the inputted [pushing force], it is recommended that the [TriggerLV] is set to the same value as the [pushing force].

2. **When pushing operation, be sure to use in "pushing operation". Also, Never hit at the stroke end.**

It causes the breakage and malfunction. The internal stopper can be broken.

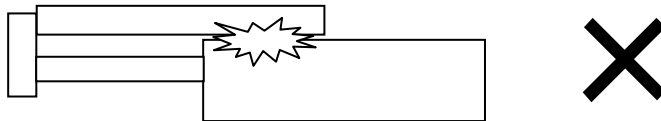

3. **The positioning force should be set to Step motor: 100% / Servo motor: 250%.**

If the positioning force is set below **Step motor: 100% / Servo motor: 250%**, it can displace the tack time, which causes an alarm.

4. **Actual speed of the product can be changed by load.**

When selecting a product, check the catalog for the instructions regarding selection and specifications.

5. **Do not apply a load, impact or resistance in addition to a transferred load during return to origin.**

Otherwise, the origin can be displaced since it is based on detected motor torque.

6. **The table and guide block are made of special stainless.**

There can be rust on the product in an environment exposed to water drops.

7. **Do not dent, scratch or cause other damage to the body and table mounting surfaces.**

It may cause a loss of parallelism in the mounting surfaces, looseness in the guide unit, an increase in sliding resistance or other problems.

8. **Do not dent, scratch or cause other damage to the surface over which the rail and guide will move.**

increased sliding resistance and Play can result.

9. **When attaching work piece, do not apply strong impact or large moment.**

If an external force over the allowable moment is applied, it may cause looseness in the guide unit, an increase in sliding resistance or other problems.

10. **Keep the flatness of mounting surace 0.02mm or less.**

Insufficient flatness of a work piece or base mounted on the body of the product can cause play at the guide and increased sliding resistance. Do not place work and do not transform the clamp face by a crowded installation etc.

11. Do not move the main body with the table fixed.

12. When mounting the product of LESH*R / LESH*L, keep the following value for bending the fixing cable. When mounting the product of LESH*D, leave a gap of 40mm or more to allow for bending of the actuator cable.

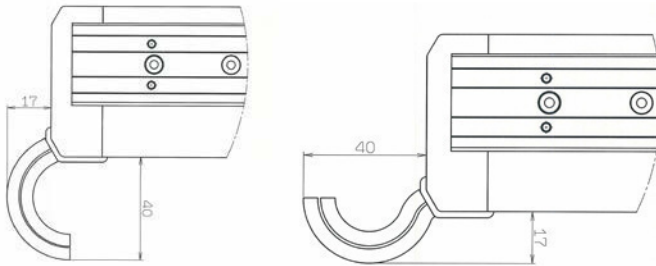

13. When mounting the product, use screws with adequate length and tighten them to the maximum torque or less.

Tightening with higher torque than the specified range may cause malfunction while the tightening with lower torque can cause the displacement of position or dropping a work piece.

Body fixed / Side mounting (body tapped)

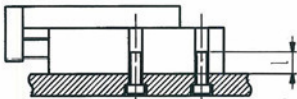

Part no.	Bolt	Max.tightening torque [Nm]	l [mm] (Max.thread depth)
LES□8R/L	M4X0.7	1.5	8
LES□8D	M5X0.8	3	10
LES16R/L	M5X0.8	3	10
LES16D	M6X1	5.2	12
LESH16□			
LES25R/L	M6X1	5.2	12
LES25D	M8X1.25	10	16
LESH25□			

Body fixed / Side mounting (through-hole)

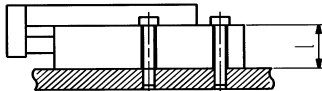

Part no.	Bolt	Max.tightening torque [Nm]	l [mm]
LES8R/L	M3X0.5	0.63	23.5
LESH8R/L			25.5
LES□8D	M4X0.7	1.5	18.2
LES16R/L	M4X0.7	1.5	33.5
LES16D	M5X0.8	3	25.2
LESH16R/L			35.5
LESH16D			27.3
LES25R/L	M5X0.8	3	49
LES25D	M6X1	5.2	39.8
LESH25R/L			50.5
LESH25D			39.5

Work fixed / Front mounting

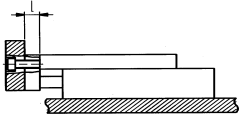

Part no.	Bolt	Max.tightening torque [Nm]	l [mm] (Max.thread depth)
LES8R/L	M3X0.5	0.63	6
LESH8R/L			5.5
LES□8D	M4X0.7	1.5	8
LES16R/L	M4X0.7	1.5	8
LES16D	M5X0.8	3	
LESH16□			
LES25R/L	M6X1	5.2	12
LESH25R/L			10
LES□25D			14

In order to prevent the work fixing bolt from hitting the table, use a bolt of a length at least 0.5mm shorter than the maximum thread depth. Longer bolts can hit the end plate, which will causes operation failure.

Work fixed / Top mounting

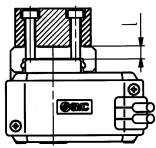

Part no.	Bolt	Max.tightening torque [Nm]	l [mm] (Min/Max.thread depth)
LES8□	M3X0.5	0.63	2.1~4.1
LESH8□			5(Max)
LES16□	M4X0.7	1.5	2.7~5.7
LESH16□	M5X0.8	3	6.5(Max)
LES25□	M5X0.8	3	3.3~7.3
LESH25□	M6X1	5.2	8(Max)

In order to prevent the work fixing bolt from hitting the guide block, use a bolt of a length at least 0.5mm shorter than the maximum thread depth. Longer bolts can hit the guide block, which causes operation failure.

Body fixed / Side mounting (Side holder)

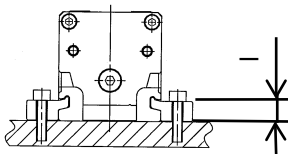

Part no.	Bolt	Max.tightening torque [Nm]	l [mm]
LES□8D	M4X0.7	1.5	6.7
LES□16D	M5X0.8	3	8.3
LES□25D	M6X1	5.2	12

When installing this product using side holders, use dowel pins for location product. If vibration or excessive external force is applied to the product, it can cause displacement of the product if dowel pins are not used.

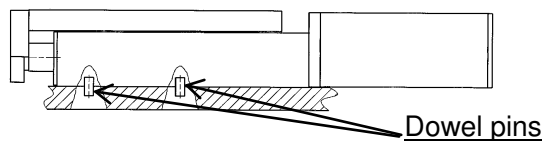

14. In pushing operation, set the product to a position of at least 0.5mm away from a work piece. If the product is set to the same position as a work piece, the following alarm and unstable operation can occur.

a. "Posn failed" alarm

The product cannot reach a pushing start position due to the deviation of work pieces in width.

b. "Pushing ALM" alarm

The product is pushed back from a pushing start position after starting to push.

15. Please decrease the transportation mass when the outside power hangs in the table.

Please note might the increase of the sliding resistance of the table when the piping duct etc. are set up in the actuator, and becoming a defective factor for operation enough.

16. When installing this product using side holders, they should be installed within the range of the dimensions shown below.

Otherwise, the product will be in an unbalanced state, causing looseness.

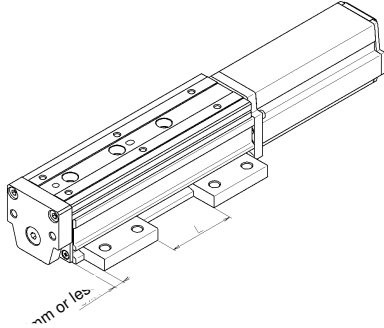

型式	L(mm)
LES□8D□-30	5 ~ 10
LES□8D□-50	20 ~ 30
LES□8D□-75	50 ~ 60
LES□16D□-30	5 ~ 10
LES□16D□-50	20 ~ 30
LES□16D□-75	60 ~ 75
LES□16D□-100	85 ~ 100
LES□25D□-30	5 ~ 15
LES□25D□-50	25 ~ 35
LES□25D□-75	60 ~ 75
LES□25D□-100	70 ~ 100
LES□25D□-125	155 ~ 170
LES□25D□-150	160 ~ 180

17. Do not peel off, and grip the masking tape on the back of the body of LESH*D.

The masking tape peels off, and the foreign body might enter in the actuator.

18. When the table operates, the space can be done between actuator (figure below arrow part). Do not place the hand and the finger, etc. because it is dangerous and do not crowd.

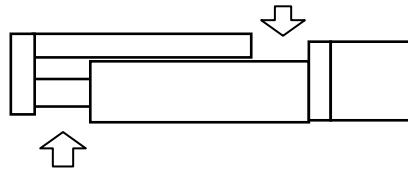

19. When fixing this product using the through hole in the mounting orientations shown below, be sure to use two side holders as shown in the figure below.

Otherwise, the product will be in an unbalanced state, causing looseness.

Body fixed
/ Ceiling mounting (through-hole)

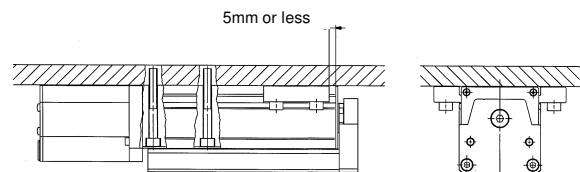

Body fixed
/ Wall mounting (through-hole)

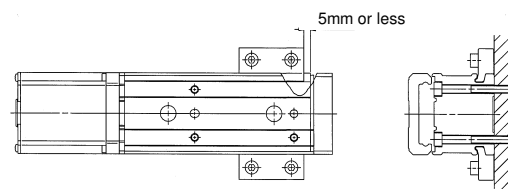

Body fixed
/ Vertical mounting (through-hole)

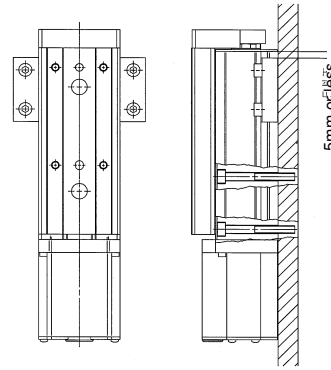

20. The product should be mounted as shown below in the figures marked with the **○**.

Unstable mounting of the product may cause operation failure, generation of abnormal noise or increase in the deflection etc.

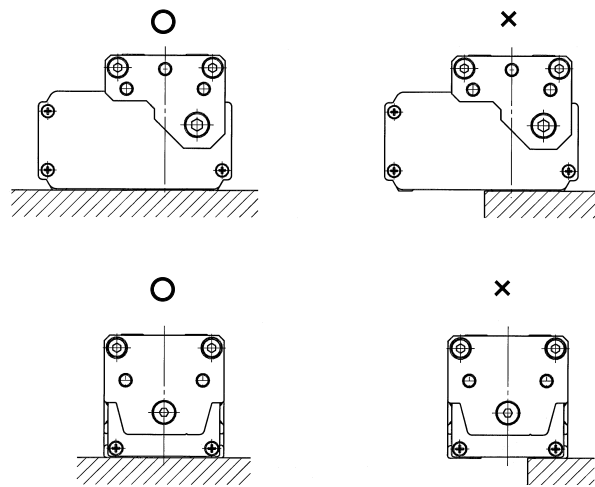

21. Even with the same product number, the table of some products can be moved by hand and the table of some products cannot be moved by hand. However, there is no abnormality with these products. (Without lock)

This difference is caused because there is a little variation with the positive efficiency (when the table is moved by the motor) and there is a large variation with the reverse-efficiency (when the table is moved manually) due to the product characteristics. There is hardly any difference among products when they are operated by the motor.

22. Remove the cap and operate manual override screw of LES**R/L with hex wrench.

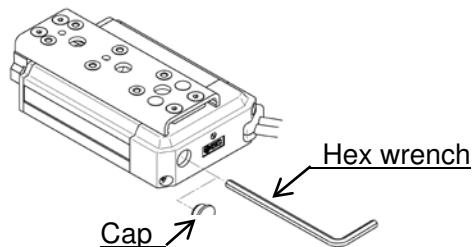

6.3 Precaution on maintenance

⚠ Caution

1. Cut the power supply during maintenance and replacement of the product.
2. Put on protective goggles when applying grease.

[Maintenance frequency]

Perform maintenance according to the table below.

	Appearance check	Check belt
Inspection before daily operation	○	-
Inspection every six months *	-	○
Inspection every 250km *	-	○
Inspection are every five million times *	-	○

*Either of inspection early time is selected.

[Items for visual appearance check]

1. Loose set screws, abnormal dirt.
2. Check of flaw and cable joint
3. Vibration, noise.

[Items for belt check] (LES**R / LES**L)

Stop operation immediately and replace the belt when belt appear to be like photos below.

a. Tooth shape canvas is worn out

Canvas fiber becomes fuzzy. Rubber is removed and the fiber becomes whitish. Lines of fibers become unclear.



Teeth become fuzzy

b. Peeling off or wearing of the side of the belt

Belt corner becomes round and frayed thread sticks out.

c. Belt partially cut

Belt is partially cut. Foreign matter caught in teeth other than cut part causes flaw.



d. Vertical line of belt teeth

Flaw which is made when the belt runs on the flange.

e. Rubber back of the belt is softened and sticky.

f. Crack on the back of the belt



6.4 Replacement of belt (LES**R / LES**L)

1. Remove the resin cover at the end.

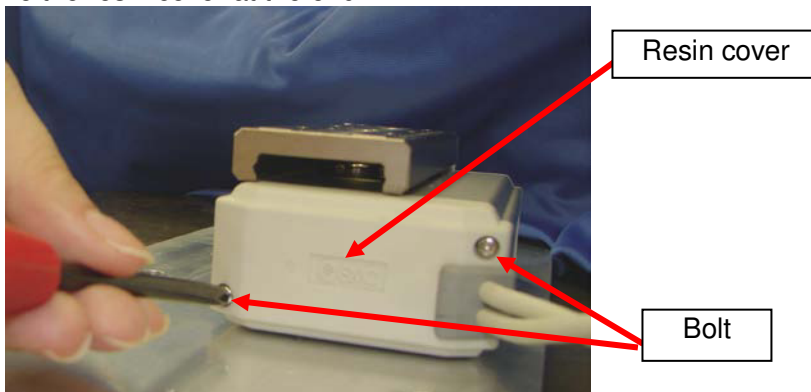

2. Displace the cover holding the cable. (If the cable is pulled forcefully, it will be disconnected)



3. Loosen the bolts fixing the motor. Do not remove the bolt completely to avoid losing them.

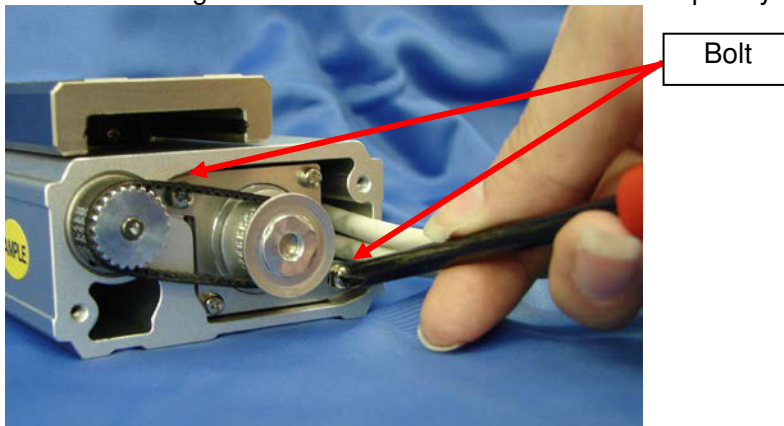

4. Remove the belt

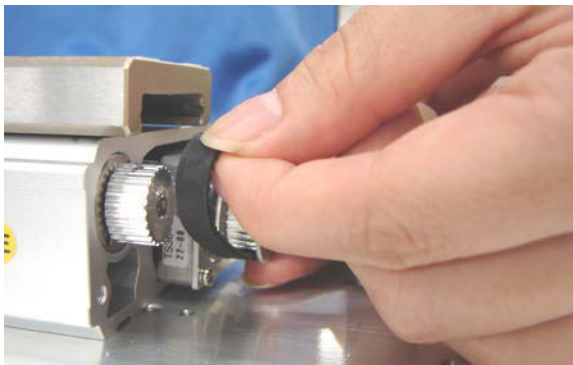

5. Hook a wire to the motor axis.

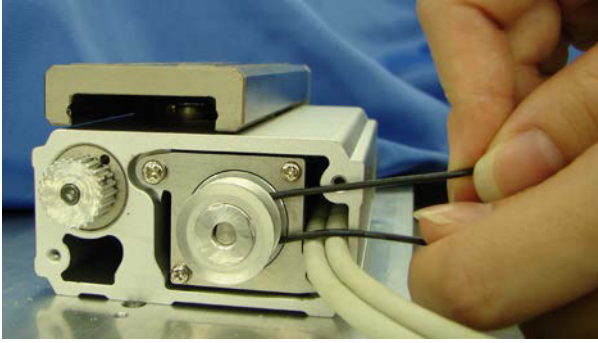

6. Set a new belt. Mount the motor pulley with belt tension force below.



Size	Belt tension (N)
LESH□8	15
LESH□16	32
LESH□25	58

7. With tensile force adjusted, tighten the bolts which fix the body to the motor.

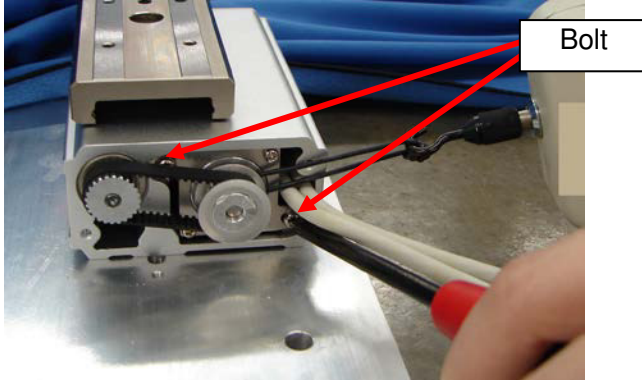

Size	Tightening torque (Nm)
LESH8	0.36
LESH□16	0.63
LESH□25	1.50

8. Remove the wire, put the cover back.

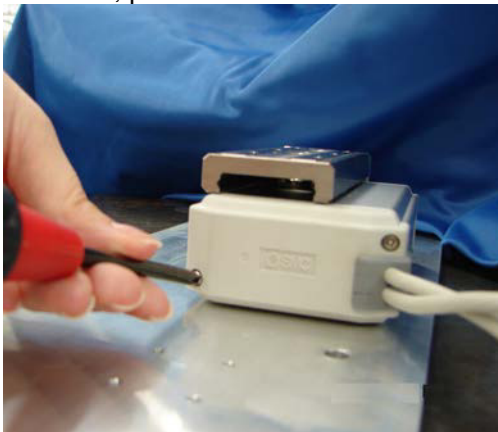

Size	Tightening torque (Nm)
LESH8	0.18
LESH□16	0.36
LESH□25	0.75

Caution (Gasket type)

Ensure that gasket is properly in the groove.



9. Check the presence of noise and displacement by test operation.

6.5 How to spreading grease

Please follow the procedure below when applying grease.

When lubrication is applied, special grease must be used. / See “2.3 Construction” on p.14-17

Extend the table to the full stroke as shown below.

Using a scrap of cloth, wipe off any grease stuck to the parts indicated by arrows steel ball moving grooves.

Next, spread grease evenly directly onto the parts indicated by arrows steel ball moving grooves using a spatula etc.

(Guideline for amount of grease to be applied: 0.1g/ 100mm)

After a short time perform return operation a few times and confirm that the grease is spread all over.

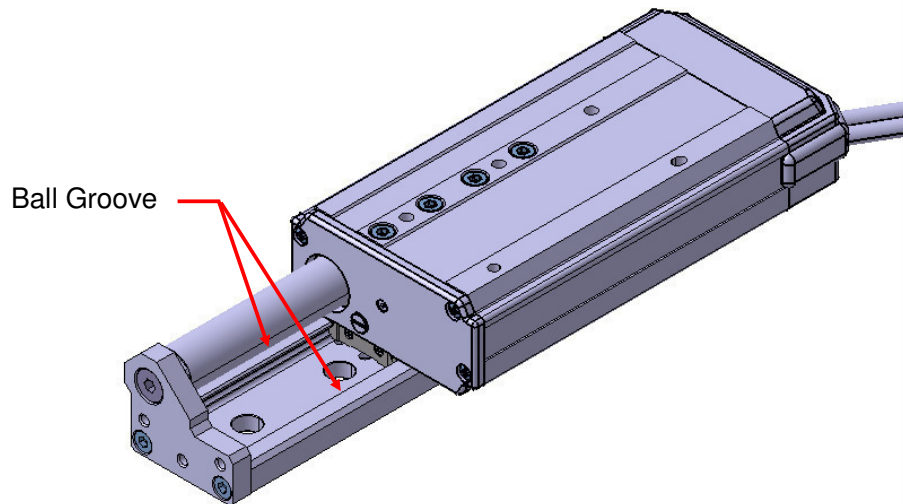



7. Troubleshooting

Alarms below are abstract of representative examples.

For other alarms, see operation manual of controller.

No.	Phenomenon	Cause	Countermeasure
1	Fail to operate / Initial stage	1) Cable is not connected, disconnected	Check if the cable is properly installed /See 4. Wiring of cable on p.37
	When power is supplied, alarm for "Phase Det ALM /code: 1-193" is generated. ↓ <Procedure of restart> "Turn the power supply off." ↓ "Turn the power supply on"	2) Load /resistance out of spec, range are applied to the actuator constantly.	Keep load and resistance within specification range. /See 2.1 Specifications on p.9-12
		3) Combination of the controller and actuator is not correct.	Combination at the time of shipment shall be kept. /See 5.3 ⚠Caution (1) on p.40
		4) The work that curves to the "End plate" is installation.	Keep the flatness of mountingu surface 0.02mm or less. /See 6.2 ⚠Caution (10) on p.43
		5) The screw to fix work to the end plate is tightened too much.	It tightens by the decided torque. /See 6.2 ⚠Caution (13) on p.45
		6) The bolt that is the fixation of work on the table presses the guide block.	Please use the bolt of appropriate length. /See 6.2 ⚠Caution (13) on p. 45
	Alarm for "Step data ALM1 /code:1-048" is generated ↓ <Procedure of restart> Input the "reset signal."	Set condition for step data is not correct. < Correct set condition > (1)Area 1 < Area 2 (2)Pushing force or more Trigger LV (3)Speed or more Pushing Speed (4)Pushing foreman or more pushing force	Review the content of step data after releasing the alarm by [RESET]. / Refer to the LEC controller operation manual.
Alarm for "Servo off ALM /code: 1-098" is generated ↓ <Procedure of restart> Input the "reset signal."	Perform the "Return to origin", the positioning operation and JOG operation during the "SVON": OFF.	Provide the operation instruction after confirming that the input signal [SVON] is ON and then the output signal [SVRE] is ON.	
Alarm for "Drive ALM /code: 1-099" is generated. ↓ <Procedure of restart> Input the "reset signal."	Perform positioning, pushing operation before retuning to origin.	Provide the operation instruction after confirming that the input signal [SETUP] is ON and then the output signal [SETON] is ON.	



No.	Phenomenon	Cause	Countermeasure
2	<p>Operation not completed / Operation continue "Posn failed/code: 1-149" is generated.</p> <p style="text-align: center;">↓</p> <p><Procedure of restart> Controller version /SV1.0 or later 1. Input the "reset signal." →"SVRE": Automatically ON</p> <p>Controller version /SV0.6* or before 1. Input the "reset signal." →"SVRE": Automatically ON 2. Input the "setup signal." → Restart operation after the completion of the"return to origin".</p> <div style="border: 1px solid black; padding: 5px; margin-top: 10px;"> <p><u>Label position for controller version</u></p>  <p>Position : Bottom SV1.0*</p> </div>	1) The Power supply does not have sufficient capacity.	Check the power consumption for each actuator and controller: If necessary replace the existing power supply with a power supply with sufficient capacity. /See 2.1 Specifications on p.9-12
		2) Load/resistance more than specified range is being applied to the actuator.	Use within specification range. /See 2.1 Specifications on p.9-12
		3) Pushing operation is preformed with "Positioning operation"	Review the content of the step data. /See 3.3 Step data setting on p.22-32
		4) For the "pushing operation", the position (target start-pushing position) is not set correctly.	Check the step data. /See 3.3 Step data setting on p.22-32
		5) Breaking of belt	Please check the belt. /See 6.4 Replacement of belt on p.48-49
		6) The cable is not connected or has been disconnected.	Confirm that the cable is connected correctly. /See 4. Wiring of cable on p.37
		7) It was not the intended origin position because the actuator pinched the work-piece during the"return to origin".	Remove the work-piece and restart the return to the intended origin position.
		8) Wrong input [0] is input as the positioning force.	Check the step data. <Moving force> /See 3.3 Step data setting on p.22-32
		9) The step data position is not changed correctly after the return to origin direction is changed.	Check the step data. <Position> /See 3.3 Step data setting on p.22-32
		10) Because the operation of the step data is set to [INC/relative], the table comes into contact with an external object and does not move due to continuous operation. (Stroke end etc.)	Check the step data. <Position> /See 3.3 Step data setting on p.22-32



No.	Phenomenon	Cause	Countermeasure
2	Operation not completed / Operation continue Alarm for "Stroke limit/code: 1-052" is generated. ↓ <Procedure of restart> Input the "RESET" signal.	Moving distance exceeds the "Stroke(+)" / "Stroke(-). (Stroke end etc.)	Check the value of the "Position" of step data and the value of the "Stroke(+)" / "Stroke(-)" of the basic parameter. /See 3.3 Step data setting on p.22-32 3.4 Parameter setting on p.33-36 /Refer to the LEC controller operation manual.
	Alarm for "Pushing ALM /code: 1-096" is generated. ↓ <Procedure of restart> Input the "RESET" signal.	1) For the pushing operation, the position, target start-pushing position, is not set correctly.	Check the step data. /See 3.3 Step data setting on p.22-32
		2) It was not the intended origin position because the actuator pinched the work-piece during the"return to origin".	Remove the work-piece and restart the return to the intended origin position.
	Operation is not completed / Operation continue Alarm for "Over motor Vol /code: 1-145" is generated. ↓ <Procedure of restart> Controller version /SV1.0 or later 1. Input the "reset signal." →"SVRE": Automatically ON Controller version /SV0.6* or before 1. Input the "reset signal." →"SVRE": Automatically ON 2. Input the "setup signal." → Restart operation after the completion of the"retun to origin".	1) If the power supply is an "inrush-current restraining type", the alarm may be generated due to voltage drop.	Replace the power supply with a non "inrush-current restraining type" power supply. /Refer to the LEC controller operation manual.
		2) The Power supply does not have sufficient capacity.	Check the power consumption for each actuator and controller: If necessary replace the existing power supply with a power supply with sufficient capacity. /See 2.1 Specifications on p.9-12
	<div style="border: 1px solid black; padding: 10px; width: fit-content;"> <p><u>Label position for controller version</u></p>  <p>Position : Bottom SV1.0*</p> </div>		

No.	Phenomenon	Cause	Countermeasure
2	<p>Alarm for "Over load/code: 1-148" is generated.</p> <p style="text-align: center;">↓</p> <p style="text-align: center;"><Procedure of restart></p> <p>Controller version /SV1.0 or later</p> <p>1. Input the "reset signal." →"SVRE": Automatically ON</p> <p>Controller version /SV0.6* or before</p> <p>1. Input the "reset signal." →"SVRE": Automatically ON</p> <p>2. Input the "setup signal." → Restart operation after the completion of the"return to origin".</p> <div style="border: 1px solid black; padding: 10px; margin-top: 20px;"> <p><u>Label position for controller version</u></p>  <div style="border: 1px solid black; padding: 5px; margin-top: 10px; width: fit-content;"> Position : Bottom SV1.0* </div> </div>	Load /resistance out of spec, range are applied to the actuator constantly.	Keep load and resistance within specification range. /See 2.1 Specifications on p.9-12

No.	Phenomenon	Cause	Countermeasure
2	Alarm for "Err overflow /code: 1-196" is generated. ↓ <Procedure of restart> "Turn the power supply off." ↓ "Turn the power supply on"	1) The lead screw had galling due to excessive external force (including vibration) or impact.	Operate within the specified range. /See 2.1 Specifications on p.9-12
		2) The Power supply does not have sufficient capacity.	Check the power consumption for each actuator and controller: If necessary replace the existing power supply with a power supply with sufficient capacity. /See 2.1 Specifications on p.9-12
		3) Load/resistance more than specified range is being applied to the actuator.	Use within specification range. /See 2.1 Specifications on p.9-12
		4) The Pushing operation is performed at the "Positioning operation position"	Review the content of the step data. /See 3.3 Step data setting on p.22-32
		5) For the Pushing operation: The position (the target start pushing position) is not set correctly.	Check the step data. /See 3.3 Step data setting on p.22-32
		6) The cable is not connected or has been disconnected.	Confirm that the cable is connected correctly. /See 4. Wiring of cable on p.37
		7) It was not the intended origin position because the actuator pinched the work-piece during the "return to origin".	Remove the work-piece and restart the return to the intended origin position.
		8) Wrong input [0] is input as the positioning force.	Check the step data. <Moving force> /See 3.3 Step data setting on p.22-32
		9) The step data position is not changed correctly after the return to origin direction is changed.	Check the step data. <Position> /See 3.3 Step data setting on p.22-32
		10) Because the operation of the step data is set to [INC/relative], the table comes into contact with an external object and does not move due to continuous operation. (Stroke end etc.)	Check the step data. <Position> /See 3.3 Step data setting on p.22-32

No.	Phenomenon	Cause	Countermeasure
2	Operation not completed / During operation (Not always, but may happen occasionally) Alarm for "Step data ALM2 /code: 1-051" is generated. ↓ <Procedure of restart> Input the "RESET" signal.	1) Command invalid (unregistered) step data.	Check if the step data is valid (registered).
		2) Different input signal to the expected step number is inputted to the controller, because of a too short an interval between the input signal of "IN*" and the "Drive" or inputting the signals at the same time.	Add an interval of 15ms (the recommendation is 30ms) or more between the input signals. / See "Operating procedure input and output signals for each operation type" on P.31-32
		3) Different input signal to the expected step number is inputted to the controller, because the input signal time was too short.	Maintain the state of the input signal for 15ms (the recommendation is 30ms) or more. / See "Operating procedure input and output signals for each operation type" on P.31-32
		4) Different input signal to the expected step number is inputted to the controller, caused by PLC or other device.	Check that the step number is inputted correctly for the required motion.
	Operation completed by unexpected motion. - No alarm / During operation (Not always, but may happen occasionally)	1) Different input signal to the expected step number is inputted to the controller, because of a too short an interval between the input signal of the "IN*" and the "Drive" or inputting the signals at the same time.	Add an interval of 15ms (the recommendation is 30ms) or more between the input signals. / See "Operating procedure input and output signals for each operation type" on P.31-32 Note) Recommend to check the "OUT" output signal for more secure operation.
		2) Different input signal to the expected step number is inputted to the controller, because the input signal time was too short.	Maintain the state of the input signal for 15ms (the recommendation is 30ms) or more. / See "Operating procedure input and output signals for each operation type" on P.31-32 Note) Recommend to check the "OUT" output signal for more secure operation.
		3) Different input signal to the expected step number is inputted to the controller, caused by PLC or other device.	Check that the step number is inputted correctly for the required motion. / See "Operating procedure input and output signals for each operation type" on P.31-32 Note) Recommend to check the "OUT" output signal for more secure operation.

No.	Phenomenon	Cause	Countermeasure
3	"Output signal" unstable the "INP output signal" turns "ON" before pushing the work piece.	The setting distance of the "[In pos]" is shorter than the distance which is from the pushing start point to the target pushing object.	Please set it as the following. "[In pos]" \geq Distance to the target pushing object. /See 6.2  Caution (14) on p.45
	During pushing operation, the "INP" output signal is ON before pushing	1) The "INP" output signal is turned "ON" because the effective pushing force of pushing operation exceeds the Trigger LV value.	Check the "pushing control selection" in the catalogue, and confirm whether the pushing force is within the range of each actuator. /See 2.1 Specifications on p.9-12
	"INP" output signal is unstable. "INP" output signal is unstable even after the positioning operation is completed.	1) The value of [In position] in step data is too small	Increase [In position] value as the following. ([0.5] or more) /See 6.2  Caution (1) on p.43
4	Positioning repeatability is out of specified range.	1) It shifts to the next operation by receiving the "INP" output signal.	Go to the next operation after confirming the "BUSY" output signal is outputted.
		2) The belt is loosened.	Readjust belt tension to the appropriated value. /See 6.4 Replacement of belt on p.49-50
5	Damage	1) Abnormal external force	Generation of interference of mechanism, eccentric load, excess load lead to cause deformation and damage of the actuator. Eliminate these
6	When mounted vertically, repeatedly shakes up and down when stopped.	1) A load exceeding the load is mounted.	Use within specification range. /See 2.1 Specifications on p.9-12

No.	Phenomenon	Cause	Countermeasure
7	Cannot be actuated manually or by manual override adjustment screw (does not operate). (At stop(EMG) or SVRE[OFF])	1) Contacts the stroke end of the actuator or the workpiece.	Check the stroke position and how workpieces are mounted.
		2) [Lock type] is selected	Supply 24VDC power supply to the [BK RLS] terminal of controller/CN1 power supply plug in order to unlock. /see 5.6 Precautions for the actuator with lock  Warning(7) on p.42
	Lock type is selected, but workpieces are dropped during stopping(EMG) or SVRE[OFF], or moved by external force.	1) Load exceeding the maximum work load is mounted, or external force more than the lock holding force is applied.	Check the mounted load and lock holding force to confirm if they are within the operation range. /See 2.1 Specifications on p.9-12
		2) 24VDC is supplied to "BK RLS" terminal of controller/CN1 power supply connector.	Stop supplying 24VDC power supply to the [BK RLS] terminal /see 5.6 Precautions for the actuator with lock  Warning(8) on p.42
8	Alarm for "Stroke limit /code: 1-052" is generated. ↓ <Procedure of restart> Input the "RESET" signal.	The actuator goes out the stroke limit specified by the basic parameters, "Stroke (+)" and "Stroke (-)" if it performs the requested operation. (Including JOG operation after return to origin)	Make sure that the basic parameter, "Stroke (+)" and "Stroke (-)" are consistent with the distance of actuator movement specified in the step data. / See "3.4 Parameter setting" on P.33-36

LES16

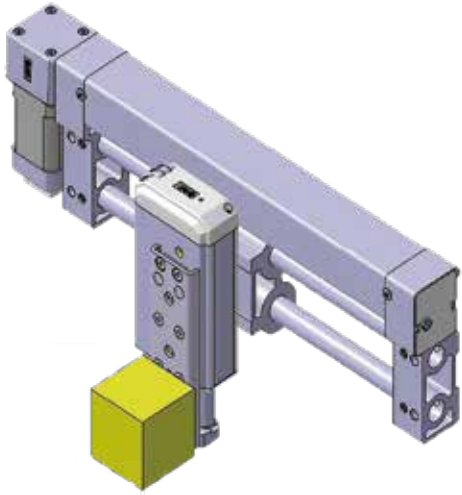

LESH16

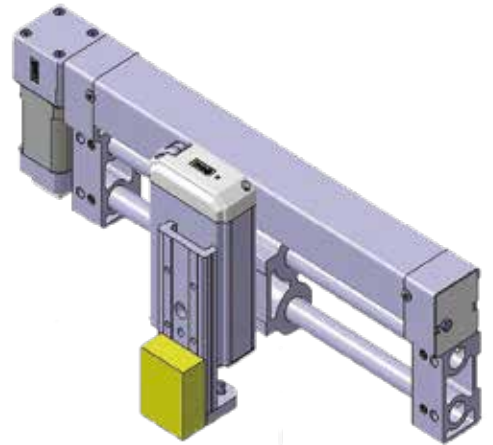

Anwendungsbeispiel

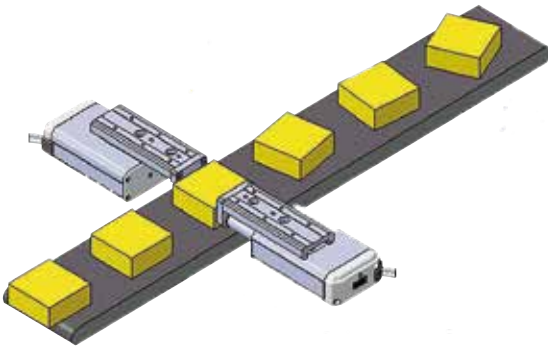

Anwendungsbeispiel

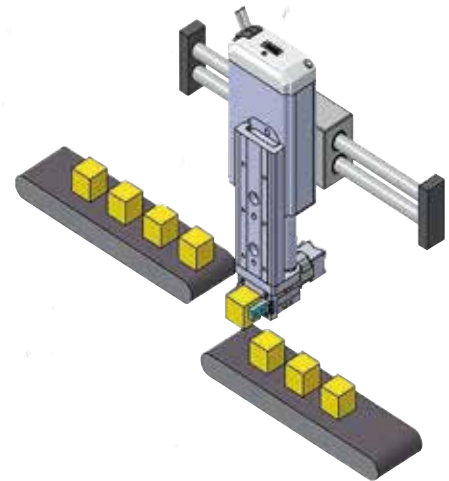

Einbaubeispiel

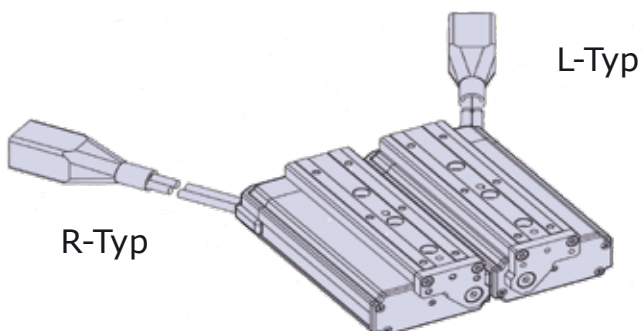

Wenn zwei Antriebe nebeneinander montiert sind, beeinflussen sie sich nicht gegenseitig, dadurch kann Platz eingespart werden.